

Duplex Silent Chains

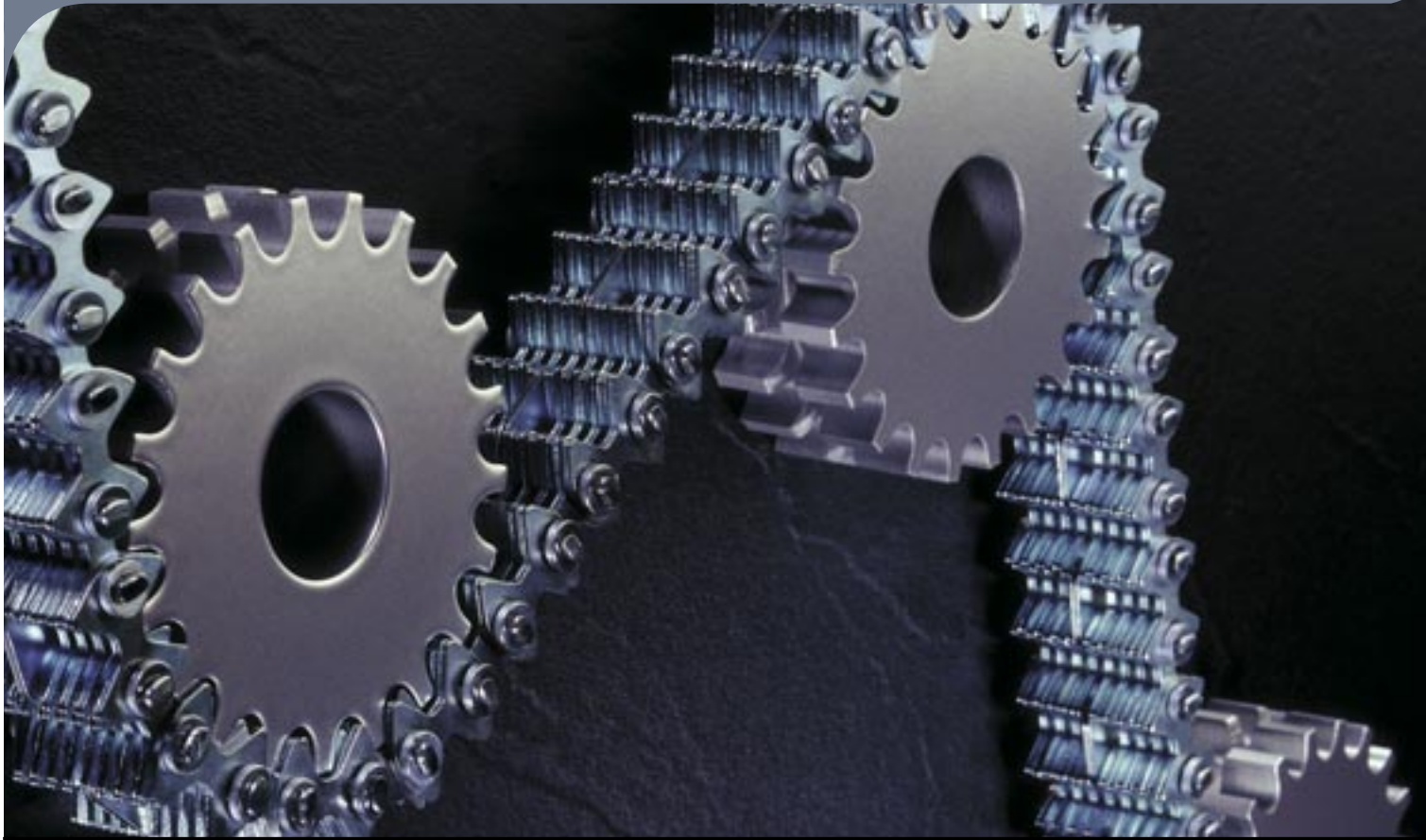

FOR SERPENTINE DRIVE SYSTEMS



Ramsey Duplex Silent Chains

For Serpentine Drive Systems

Ramsey Products specializes in the design, manufacture, and application of silent chain drives, also known as inverted tooth or toothed chain drives. For more than 95 years this has been our focus, and today we remain committed to providing our customers with the world's widest range of top quality silent chain products.

Because we specialize in silent chain, we understand how important it is to choose the right chain and sprockets for each application. Whether selecting components for a new application, replacing an existing chain, or custom designing a chain, our goal is to provide our customers with the most practical and cost effective solutions. If a job can be done with silent chain, we will help find the best chain for the job, at the lowest possible cost.

Many companies sell silent chain, but no one offers the product range, quality, and support provided by Ramsey. In addition to our extensive standard product line, we offer replacements for most competitors' chains, as well as custom designed chains. We also provide free consultation and drive selection assistance through our staff of experienced designers. Whether your requirement is a single chain, or a much larger volume, our sales and engineering staff has the experience to assist you. With warehouses and representatives around the world, we welcome the opportunity to serve you.

ABOUT THIS CATALOG

Duplex chains are designed to engage and drive sprockets from both sides of the chain. Ramsey manufactures three different styles of duplex silent chain; each has unique features and advantages:

RAMPOWER DUPLEX SERIES

Rampower duplex, also known as RP duplex, provides approximately two times the power capacity of standard SC duplex chain. RP duplex is often well suited for new or replacement applications where power or speed requirements exceed the capability of SC duplex chain.

SC DUPLEX SERIES

SC duplex chains have been around the longest, are used primarily in replacement applications, and are often the most economical. SC duplex offers the advantage of reduced weight, but with a lower power capacity.

RAMFLEX SERIES

Ramflex is Ramsey's most robust duplex chain design; it is particularly well suited to applications where shock or very high loads are encountered, or where space is limited. Ramflex also directly interchanges with chain produced by some European manufacturers.

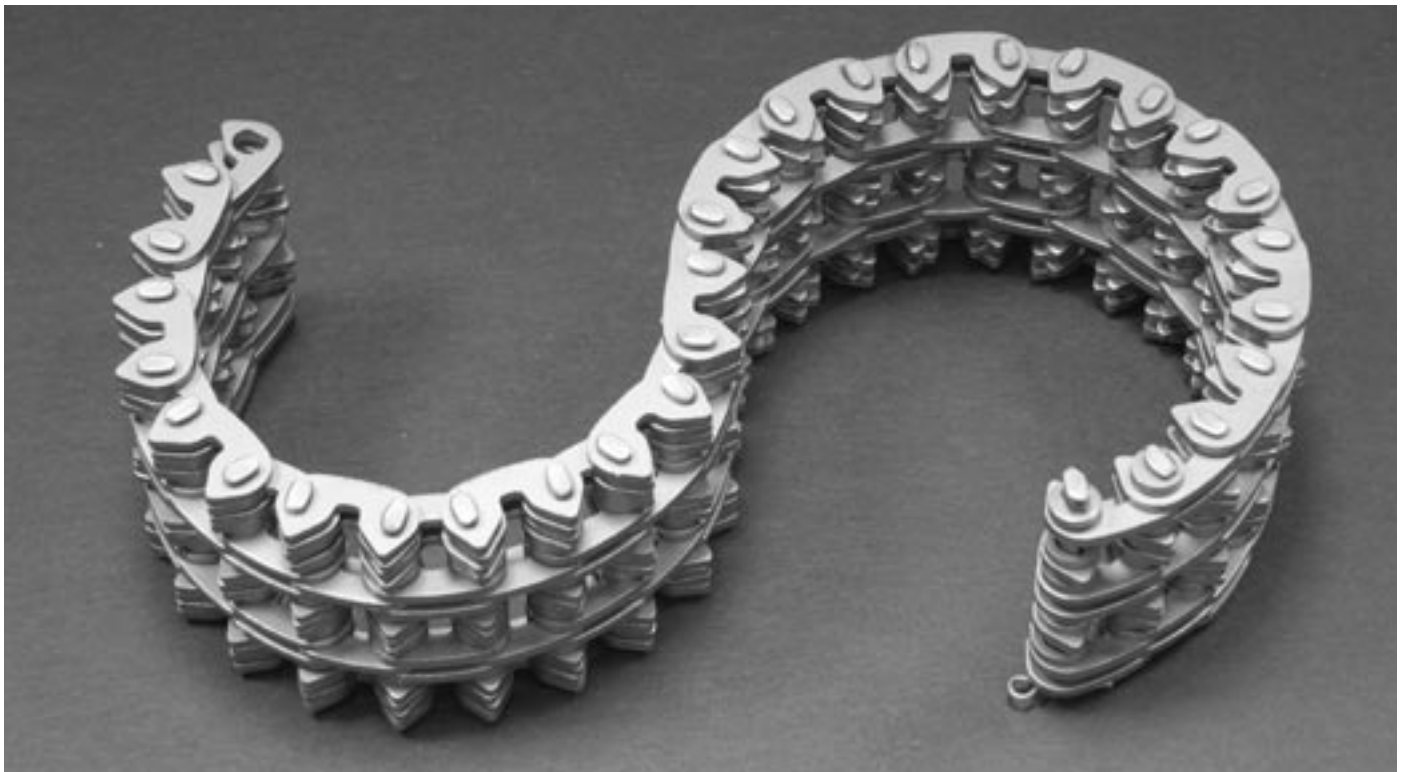

CONTENTS

Silent Chain Fundamentals.....	2-3
Chain Identification.....	4
Rampower.....	5
SC.....	6
Ramflex.....	7
Sprockets.....	8-9

Engineering.....	9
Drive Selection.....	10-11
Lubrication and Installation.....	12
Connection.....	13
Service Factors.....	14
Maintenance and Formulas.....	15

WHY DUPLEX SILENT CHAIN?

Duplex silent chain offers today's drive designer unique advantages and options for transmitting power smoothly, efficiently, and economically. Designed specifically for transmitting power and motion from both sides of the chain, duplex is most often used where the rotation of three or more shafts must be synchronized. Incorporating proven silent chain technology, Ramsey duplex chains provide many of the advantages of other types of silent chain, including reduced noise and vibration, and efficiencies as high as 99%. Add to these features a wide range of available chain and sprocket sizes and the result is an extremely flexible and powerful system for power transmission.

Duplex Silent Chain Compared With Roller Chain

1. Transmits power more smoothly, less vibration
2. Lower impact load during sprocket engagement
3. Reduced noise
4. Higher load and speed capacity
5. Higher efficiency (as high as 99%)
6. Longer sprocket life
7. More uniform wear and consistent velocity

Duplex Silent Chain Compared With Gears

1. Quieter than spur gears
2. More economical with large center distances
3. Less restrictive shaft parallelism tolerances
4. Greater elasticity to absorb shock
5. No end thrust as with helical gears
6. Lower tooth bearing loads

Duplex Silent Chain Compared With Belts

1. Detachable and therefore more easily installed
2. Higher efficiency (as high as 99%)
3. Larger ratios possible
4. No slippage
5. Lower bearing loads
6. More effective in oily environments
7. Less affected by temperature or humidity
8. More available widths and lengths

CHAIN CONSTRUCTION

Ramsey duplex chains are made from hardened alloy steel components, including flat tooth shaped driving links, pins that form the chain joint, and in some cases, guide links or spacer bushings. The driving links engage sprocket teeth much the way a rack and pinion mesh. The pins hold the joint together and allow the chain to flex. Guide links serve to retain the chain on sprockets and spacers act to separate rows of opposed driving links.

DRIVING LINKS

Driving links, also known as plain links, engage sprocket teeth with less sliding and less impact than other types of chain. This results in quieter operation and longer sprocket life. Reduced impact loading also allows for higher operating speeds.

PINS AND JOINTS

Ramflex, Rampower, and SC chains use highly specialized two-pin joints that have been developed to maximize chain load and speed capacity, while reducing friction and wear. Ramflex and Rampower use case hardened "crescent" shaped pins, while SC chains contain the "D" shaped pins, also case hardened for maximum wear resistance.



RP Duplex and Ramflex chain joints have "crescent" shaped pins



SC Duplex chain joints have "D" shaped pins

SPACER BUSHINGS AND GUIDE LINKS

Ramflex chains may contain guide links to maintain proper tracking of the chain on sprockets. They can be positioned on the outer edges of the chain in side guide or in the middle of the chain with center guide. RP and SC duplex chains do not require guide links, but may include spacer bushings that separate rows of oppositely pointing links.



Guide Link



Spacer Bushing

Silent Chain Fundamentals

HOW TWO PIN JOINTS WORK

The illustration below shows how the Ramsey two pin joint works. As a chain engages the sprocket and moves from position A to position B, the convex surfaced pins roll upon one another. This rolling action eliminates the sliding friction and galling that occurs in other types of chain. Pin action also minimizes the

effects of chordal action by slightly increasing chain pitch and internally moving the pitch point up to coincide with the sprockets pitch circle. As a result, the chain smoothly and efficiently engages the sprocket, very nearly tangent to the pitch circle. The smoothness and lack of vibration results in a quiet drive with higher load and speed capability.

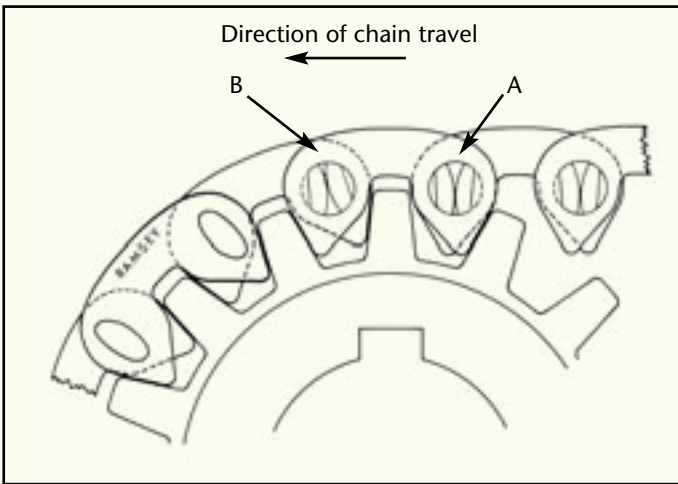

Ramsey Two Pin Joint

A Ramsey silent chain operating at high speed. Note the smoothness and lack of vibration

Another advantage of two pin joints is that they wear uniformly over the life of the chain. Unlike roller chain

and other single pin chains, this provides for consistent linear velocity throughout the length of a chain.

UNIFORM ELONGATION OF SILENT CHAIN

The diagram compares the wear patterns of two chain types. On the left, a silent chain with two-pin joints is shown where all three pitch intervals have elongated by the same amount, labeled as $\text{pitch} + \Delta P$. On the right, a roller chain is shown where the pitch intervals alternate: the first and third intervals remain at the original 'pitch', while the middle interval has elongated to $\text{pitch} + \Delta P$.

Silent chains employing two pin joints wear uniformly, with each pitch elongating by the same ΔP . Because pitch is consistent, chain wear does not produce velocity variation or vibration.

Roller chain and most other chains with straight sidelinks do not elongate uniformly. The pitch of links containing rollers stays essentially constant, while wear of bushings and pins causes every other pitch of the chain to elongate by ΔP . This creates velocity variations and vibration as the chain wears.

Chain Identification

1. **STYLE** - Chain style can be identified by the shape of the driving links.



Rampower Duplex



SC Duplex



Ramflex

2. **PITCH** - Chain pitch, the distance between pin contact points, is easily estimated by measuring the distance between the centers of three consecutive pin heads and dividing by 2. Pitch is typically expressed in inches.



Actual Pitch



Estimated Pitch = $\frac{X}{2}$

3. **WIDTH OVER HEADS** - Chain width over heads is simply the distance across the chain's "riveted" or "headed" pins.



4. **ASSEMBLY** - (For SC and Rampower duplex only) Chain assembly is identified by counting the number of adjacent, similarly arranged links across the width of the chain.

Rampower Duplex with 5-5-5 Assembly



5 links down

5 links up

5 links down

5. **GUIDE TYPE** - (For Ramflex only) Chain guide type is either center guide or side guide depending on the location of guide links in the chain.



Center Guide



Side Guide

Rampower Duplex

RAMPOWER DUPLEX ASSEMBLIES

1/2" Pitch



3/4" Pitch



Pitch	Part Number	Nominal Width (mm)	Assembly	Width Over Heads WH (mm)	Width Over Links WL (mm)	Width At Connector WC (mm)	Weight (kg/m)
1/2" 12,7mm	RPD5404	25	5-5-5	30,5	27,2	31,8	1,79
	RPD8406	38	8-7-8	43,2	39,9	44,7	2,53
	RPD8408	51	8-15-8	55,9	52,6	57,4	3,27
	RPD11408	51	11-9-11	55,9	52,6	57,4	3,27
	RPD12412	76	12-23-12	81,6	78,2	83,0	4,76
	RPD16416	102	16-31-16	107,2	103,9	108,7	6,2
	RPD22416	102	22-19-22	107,2	103,9	108,7	6,25
	RPD10420	127	10-19-19-19-10	132,6	129,3	134,1	7,74
	RPD16424	152	16-23-15-23-16	158,2	154,9	159,8	9,23
3/4" 19,05mm	RPD6606	38	6-5-6	46,0	39,1	50,3	3,87
	RPD8608	51	8-7-8	58,4	51,3	62,5	4,76
	RPD8610	64	8-13-8	70,9	63,8	75,0	5,80
	RPD9612	76	9-17-9	83,1	76,2	87,4	6,72
	RPD12616	102	12-23-12	107,7	100,8	112,0	8,78
	RPD9620	127	9-13-13-13-9	132,4	125,5	136,7	10,71
	RPD9624	152	9-17-17-17-9	157,2	150,1	161,3	12,80

The above table shows the most common chain assemblies. Other assemblies and widths are available.

SC Duplex

SC DUPLEX ASSEMBLIES



Pitch	Part Number	Nominal Width (mm)	Assembly	Width Over Heads WH (mm)	Width Over Links WL (mm)	Width At Connector WC (mm)	Weight (kg/m)	h (mm)	d (mm)	t (mm)
3/8" 9,5mm	D4304	25	4-5-4	20,3	17,5	21,3	1,04	9,9	4,6	1,52
	D7306	2/38	7-7-7	39,4	36,6	40,4	1,49			
	D7308	51	7-15-7	52,3	49,5	53,3	2,08			
	D11312	76	11-23-11	78,0	75,2	79,0	3,13			
1/2" 12,7mm	D4404	25	4-5-4	20,6	17,5	22,4	1,49	13,5	5,3	1,52
	D7406	2/38	7-7-7	39,6	36,6	41,4	2,08			
	D7408	51	7-15-7	52,6	49,5	54,4	2,53			
	D10408	51	10-9-10	52,6	49,5	54,4	2,53			
	D11412	76	11-23-11	78,2	75,2	79,8	3,42			
	D15416	102	15-31-15	103,6	100,6	105,4	4,61			
	D21416	102	21-19-21	103,6	100,6	105,4	4,61			
	D9420	152	9-19-19-19-9	129,3	126,2	131,1	5,66			
D15424	152	15-23-15-23-15	155,0	151,9	156,5	6,70				
3/4" 19,05mm	D5606	38	5-5-5	39,4	35,3	42,9	2,97	20,6	10,4	2,03
	D7608	51	7-7-7	51,8	47,8	55,4	4,02			
	D7610	64	7-13-7	64,5	60,5	68,1	5,21			
	D8612	76	8-17-8	77,0	73,0	80,5	6,10			
	D11616	102	11-23-11	101,9	97,8	105,4	8,33			
	D8620	127	8-13-13-13-8	126,7	122,7	130,3	10,40			
	D8624	152	8-17-17-17-8	151,9	147,8	155,5	12,65			

The above table shows the most common chain assemblies. Other assemblies and widths are available.

RAMFLEX ASSEMBLIES

Center Guide (CG)



Side Guide (SG)



Pitch	Part Number	Nominal Width (mm)	Guide Type	Width Between Guides WBG (mm)	Width Over Heads WH (mm)	Width Over Links WL (mm)	Width At Connector WC (mm)	Weight (kg/m)	Breaking Load (N)	h (mm)	t (mm)
3/8" 9,5mm	RF3-015A	15	SG	12,5	22,4	15,7	24,4	0,89	17,347	13,8	1,52
	RF3-020A	20	SG	18,8	28,7	22,1	30,5	1,34	25,176		
	RF3-025	25	CG	NA	33,3	26,7	35,3	1,49	32,915		
	RF3-030	30	CG	NA	39,6	33,0	41,7	1,79	41,011		
	RF3-040	40	CG	NA	46,0	39,4	48,0	2,23	48,038		
	RF3-050	50	CG	NA	58,7	52,1	60,5	2,83	64,051		
	RF3-065	65	CG	NA	71,1	64,5	73,2	3,57	79,174		
1/2" 12,7mm	RF4-315A	15	SG	12,5	21,8	15,2	23,9	1,19	28,289	18,0	1,52
	RF4-320A	20	SG	17,3	26,4	19,8	28,5	1,49	734,516		
	RF4-325	25	CG	NA	32,5	25,9	34,5	1,93	52,931		
	RF4-330	30	CG	NA	38,6	32,0	40,6	2,38	66,008		
	RF4-340	40	CG	NA	44,7	38,1	46,7	2,68	78,018		
	RF4-350	50	CG	NA	56,9	50,3	59,0	3,57	104,083		
	RF4-360	60	CG	NA	66,0	59,4	68,0	4,17	120,185		
	RF4-365	65	CG	NA	69,1	62,5	71,1	4,46	128,992		
	RF4-375	75	CG	NA	81,3	74,7	83,3	5,36	153,990		
	RF4-380	80	CG	NA	87,4	80,8	89,4	5,80	165,999		
RF4-3100	100	CG	NA	105,7	99,0	107,7	6,99	203,985			
3/4" 19,05mm	RF6-530A	30	SG	26,9	38,6	31,0	42,2	3,42	72,013	26,9	2,03
	RF6-535A	35	SG	34,5	46,7	39,1	50,3	4,61	95,009		
	RF6-550A	50	SG	46,7	59,2	51,6	62,7	5,95	139,000		
	RF6-535	35	CG	NA	42,7	35,0	46,2	4,02	95,009		
	RF6-550	50	CG	NA	59,2	51,6	62,7	5,65	139,000		
	RF6-565	65	CG	NA	75,7	68,1	79,2	7,44	184,014		
	RF6-590	90	CG	NA	100,3	92,7	103,9	10,12	251,001		
	RF6-5125	125	CG	NA	133,4	4125,7	136,9	13,54	340,005		
RF6-5135	135	CG	NA	141,5	133,9	145,0	14,43	361,978			

The above table shows the most common chain assemblies. Other assemblies and widths are available.

Sprockets

Ramsey manufactures a full line of sprockets for SC duplex, Rampower duplex, and Ramflex chains. All sprockets can be fully machined to your specifications or you can request they be supplied with an unfinished bore to allow secondary machining. Ramsey also supplies sprockets to replace most competitor's products. We welcome all inquiries.

MATERIALS

Sprockets are typically made from carbon steel or ductile iron, with sprocket teeth heat treated to a minimum Rockwell hardness of Rc 50. Class 30 gray iron is also available, but with unhardened teeth. Other materials are available, subject to customer preference, sprocket size, cost, and availability.

PERFORMANCE GUIDELINES

In general, larger sprocket diameters will provide for smoother operation, less vibration, and longer life. SC duplex, Rampower duplex, and Ramflex chains require sprockets with at least 21 teeth. Also, to assure proper meshing with chain our sprockets are manufactured to established, proprietary, Ramsey specifications. Sprockets for SC duplex and Rampower duplex have similar tooth profiles but may differ dimensionally due to differences in chain construction. Ramflex sprockets have a unique tooth profile that is not compatible with SC or Rampower duplex. When purchasing sprockets it is very important to specify the type of chain being used.



SPROCKET FACE PROFILES

SC and Rampower Duplex

Sprocket face profile is determined by the chain assembly and the side of the chain on which the sprocket will run. For example, the figure below shows a Rampower duplex chain with a 5-5-5 assembly. The chain is oriented so that the teeth of the links on the outer edges of the chain are facing down. With the chain in this position the major and minor sides of the chain are identified. Sprocket face profiles are shown for both the major and minor sides of the chain.

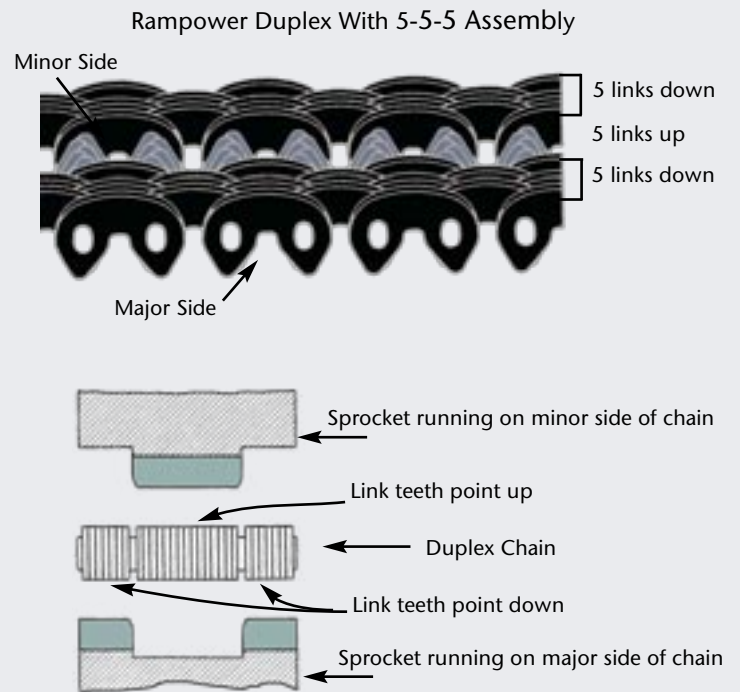

Ramflex

Sprocket face profiles for Ramflex chain will be either center guide or side guide, depending on the guide type of the chain being used.

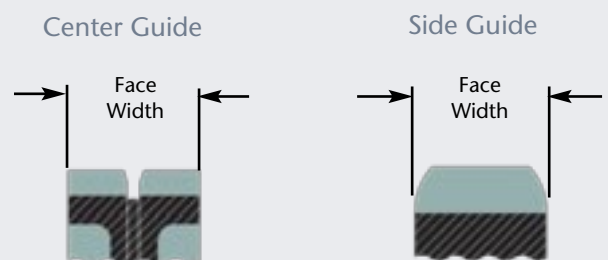

Sprocket and Engineering Information

SPROCKET HUB TYPES

F = Nominal Chain Width
 HD = Hub Diameter
 B = Bore
 LTB = Length Through the Bore
 OD = Outside Diameter
 HP = Hub Projection

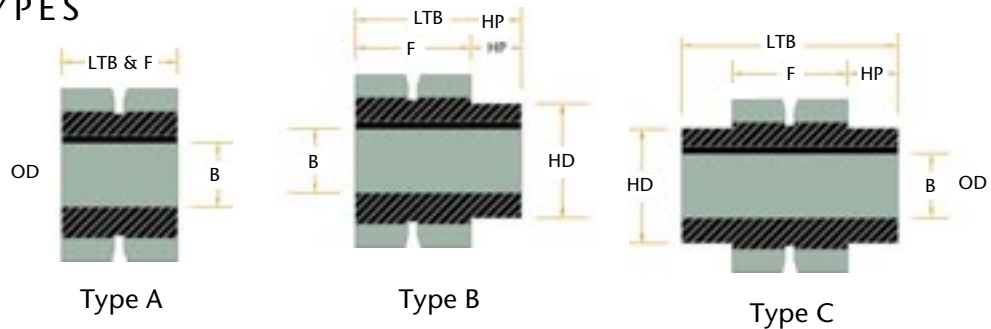

MAXIMUM SPROCKET HUB AND BORE DIAMETERS

Teeth	3/8" Pitch		1/2" Pitch		3/4" Pitch	
	Hub (mm)	Bore (mm)	Hub (mm)	Bore (mm)	Hub (mm)	Bore (mm)
21	50,0	33,0	67,5	47,5	100,5	69,5
22	50,0	34,5	71,5	49,0	107,0	76,0
23	56,0	38,0	75,5	54,0	112,5	82,5
24	58,5	41,0	79,5	57,0	119,0	84,0
25	62,5	44,5	83,5	60,0	125,5	89,0
26	66,0	46,0	87,0	62,0	131,5	95,0
27	68,0	47,5	91,0	66,5	137,0	100,0
28	71,5	50,8	95,0	68,5	143,5	106,0
29	74,5	52,5	100,0	71,5	149,0	111,0
30	377,5	54,0	104,0	76,0	155,5	114,0
31	81,0	54,0	108,0	77,5	162,0	114,0
32	83,5	55,5	112,0	81,0	167,5	119,0
33	86,5	58,5	116,0	82,5	173,5	125,0

DRIVE DESIGN SUGGESTIONS

SPROCKETS: Sprockets must have a minimum of 21 teeth to assure proper chain wrap. For smoother, quieter drives, use a larger number of teeth.

DRIVE RATIOS: Ratios of 12:1 or greater are possible, but above 8:1 it is usually desirable to make the reduction in two steps.

CHAIN TENSIONING: For best results it is important to maintain proper chain tension. A correctly tensioned chain will not sag excessively when stationary and will not whip or surge when running. It is also important not to over tension as this could lead to pre-mature chain failure. Use as little tension as is necessary to produce smooth drive operation. Tensioning can be achieved through the use of idler sprockets or adjustable drive shafts. Proper tension is especially important in drives with non-horizontal shafts.

SHAFT CENTER DISTANCE AND WRAP ANGLE: The center distance should be great enough that the chain wraps each sprocket at least 120 degrees. Center distances should generally not exceed 60 pitches.

CHAIN LENGTH: Chain length must be an even number of pitches. Offset sections are not available with duplex style chains.

TENSIONING DEVICES: An idler sprocket can often be used to maintain tension on fixed center drives.

CHAIN WIDTH: The use of a wider than recommended chain will result in a more rugged drive and may extend drive life.

DRIVE ENCLOSURES. Fully enclosed drives with proper lubrication are desirable for maximum service life and for the safety of personnel.

Drive Selection

DRIVE SELECTION-STEP BY STEP

Drive selection is an iterative process and there is often more than one combination of chain and sprockets that will work well in a given situation. As a starting point it is helpful to initially assume that ½" pitch Rampower duplex will be used in the drive.

Information Needed:

- Type of power source and application
- Shaft center distances (CD)
- Power to be transmitted (W)
- Shaft diameters and keyway sizes
- RPM of shafts
(N1=fastest shaft speed, N2, N3, N4, N5, etc)

FOLLOW THESE STEPS

1. Construct a preliminary drive layout, as shown on page 11, and identify the power transmitted, the diameter, rotational direction and speed of the driving shaft, and the speed of the fastest shaft in the layout.
2. Select a preliminary number of teeth for the sprocket on the fastest shaft (Z1); choose the smallest number of teeth that will accept the diameter of the driving shaft (see table on page 9). If the driving shaft is not the fastest shaft, compute the number of teeth in the driving sprocket(Zd) as follows:

$$Z_d = Z_1 \times \frac{N_1}{N_d}$$

3. Choose a service factor from the table on page 14.
4. Compute the design horsepower (W_d) by multiplying the power to be transmitted (W) by the service factor.
5. Compute the required chain width(C_w). using one of the following equations. Initially assume 1/2" pitch Rampower is used.

$$\text{For Rampower Duplex } C_w = \frac{37.3(W_d)}{p(V)(1 - V^2(1.34 \times 10^{-8}))}$$

$$\text{For SC Duplex } C_w = \frac{30,060(W_d)}{p(V)(425 - V/(Z_1 - 8))}$$

$$\text{For Ramflex } C_w = \frac{10.34(W_d)(1 + 0.00254V)}{p \cdot V}$$

$$\text{For } V > 400 \text{ ft/min } C_w = \frac{21.7(W_d)}{p(V)(1 - V^2(2.2 \times 10^{-8}))}$$

C_w = required width (inches)
 W_d = design power (hp)
 p = pitch (inches)
 V = chain speed (ft/min)

6. Check the chain ordering charts (pages 5-7) to see if there is a chain width equal or larger than the required width calculated in step 5. If there is a suitable width available then goes to step 7. If the required width is much smaller than the smallest available width then go back to step 5 and re-compute using ½" pitch SC duplex. If the required width is wider than any available width then go back to step 5 and re-compute using ½" pitch Ramflex.
7. Based on the desired speed of each shaft, compute the number of teeth for all remaining sprockets, making sure that each sprocket will accept the shaft diameter.
8. Construct a final drive layout using the actual pitch diameter for each sprocket.

$$P_d = \frac{p}{\sin(180/Z)}$$

Referring to the layout, verify that the chain wraps each sprocket by at least 120 degrees and then compute chain length. These calculations are most easily performed with a CAD program, but can also be completed using geometry and trigonometry.

9. Based on the chain speed, select a method for lubricating the drive.

$$\text{Chain speed } (V) = \frac{pZN}{12}$$

Forced feed lubrication will provide optimum results and is recommended whenever chain speeds exceed 2500 ft/min. Drip or bath type lubrication may be acceptable at lower speeds. Additional information on lubrication is given in the section describing lubrication. Also, if the drive will not operate inside a housing, a chain enclosure is recommended.

Drive Selection

DRIVE SELECTION EXAMPLE

Plastic extruder

Power source: electric motor

Power: 15 hp

Shaft speeds: 1750 RPM (N1), 1600 RPM (N2), 400 RPM (N3), 400 RPM (N4)

Shaft diameter (N1) = 1.000 inches

1. A preliminary drive layout is illustrated below. Our initial drive selection will assume that 1/2" pitch Rampower is used.
2. The driving shaft #1 is also the fastest shaft in this example. We select an initial sprocket size of 21 teeth. From the sprocket table on page 9, the maximum bore for the 21 tooth sprocket is 1.875", so this sprocket will accommodate the 1.000" shaft diameter.
3. Determine the service factor (SF), using the chart on page 14. Under Rubber and Plastics equipment the service factor for an extruder is 1.5.
Service factor = 1.5
4. Compute the design horsepower (W_d) by multiplying the power to be transmitted (W) by the service factor.
 $W_d = W \times SF = 15 \text{ hp} \times 1.5 = 22.5 \text{ hp}$
5. Calculate minimum chain width (C_w).
 $W_d = 22.5 \text{ hp}$
 $V = pZN = (0.5 \times 21 \times 1750)/12 = 1,531 \text{ fpm}$
$$C_w = \frac{37.3(22.5)}{(0.5)(1531)(1 - (1531)^2(1.34 \times 10^{-8}))}$$

$$C_w = \frac{839.25}{(0.5)(1531)(.9686)} = 1.13 \text{ inches}$$
6. The nearest larger standard Rampower chain width, from page 5, is RPD8406, 1.5 inches wide, with an 8-7-8 assembly.
7. Compute the number of teeth in remaining sprockets:
 $Z_2 = 21 \times \frac{1750}{1600} = 23$
 $Z_3 = 21 \times \frac{1750}{400} = 92$
 $Z_4 = 21 \times \frac{1750}{400} = 92$
8. Compute the pitch diameter for each sprocket and construct a final drive layout. The final layout is used to verify that the chain wraps each sprocket by at least 120

degrees and to compute chain length. Wrap and chain length calculations are most easily performed within a CAD program and have been excluded from this illustration.

$$\text{pitch dia \#1} = \frac{0.5}{\sin(180/21)} = 3.355 \text{ inches}$$

$$\text{pitch dia \#2} = \frac{0.5}{\sin(180/23)} = 3.672 \text{ inches}$$

$$\text{pitch dia \#3 and \#4} = \frac{0.5}{\sin(180/92)} = 14.645 \text{ inches}$$

9. The chain speed of 1531 fpm indicates that either bath or forced feed lubrication should be employed.

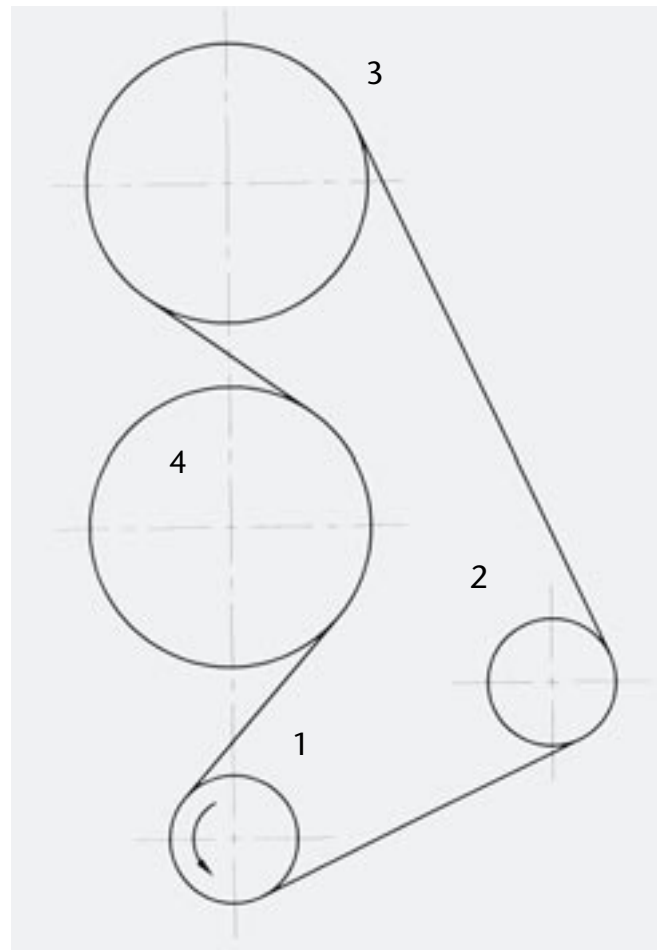

Sample Drive Layout

Installation and Lubrication

LUBRICATION

Proper drive lubrication is essential for a long service life. In sufficient quantities the lubricant penetrates chain joints to protect against corrosion, dissipate heat, cushion impact, and flush away debris.

For most applications a good grade of non-detergent petroleum based oil is recommended. Multiviscosity oils are not recommended. Generally, greases and high viscosity oils are too thick to penetrate chain joints and should be avoided.

Lubricant may be applied by drip, bath, or forced feed, depending on the chain speed. Forced feed lubrication is optimum and generally, one should choose the best method of lubrication available.

Ambient Temperature	Recommended Lubricant
< 40°F / < 4°C	SAE 5*
40-90°F / 4 - 30°C	SAE 10*
> 90°F / > 30	SAE 20

*Type A or B Automatic Transmission Fluid may be substituted

Chain Speed	Lubrication Method
< 1,000 ft/min / < 5 m/s	Manual or Drip
1,000 - 2,500 ft/min / 5 - 12,5 m/s	Bath
> 2,500 ft/min / > 12,5 m/s	Forced Feed

DRIVE INSTALLATION

SHAFT PARALLELISM

Shaft parallelism should be checked before installing sprockets. Typically shafts should be parallel to within 0.005 inches per foot. Ramsey should be consulted for applications where shafts are not horizontal.

SPROCKET ALIGNMENT

Sprockets should be aligned on the shafts so there is little or no lateral offset between sprocket faces. Excessive wear will result if the sprockets are not properly aligned.

CHAIN CONNECTION

During connection, it is very important that the ends of the chain be secured and properly laced together.

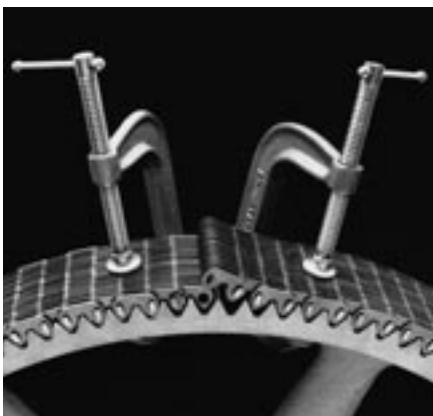
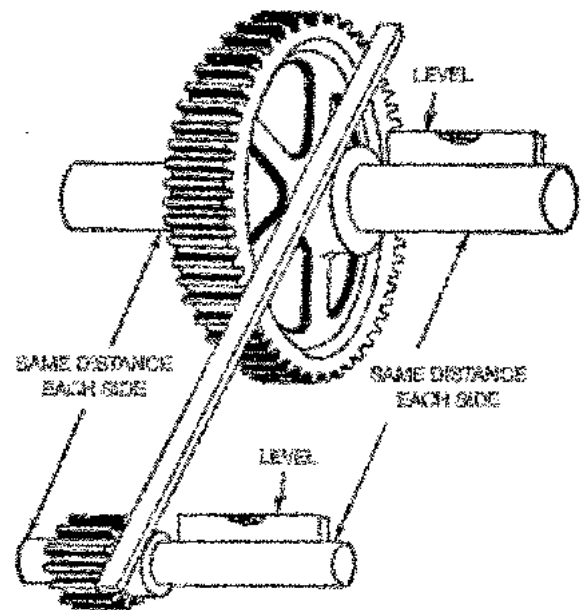

Chain clamped to the sprocket to simplify connection.



Symmetric chain lacing during connection

Chain Connection

Once the links in each end are properly laced together, chain connection is completed by first inserting the longer pin and then the shorter pin. Position the pins so that the convex surfaces contact one another. Complete the connection by putting a washer, or side link, on the long pin and then fasten with a spirol pin or cotter. Optional annealed connecting pins are available that are secured by peening over the pin end. With SC and Rampower duplex it is important to properly locate spacer bushings during connection.

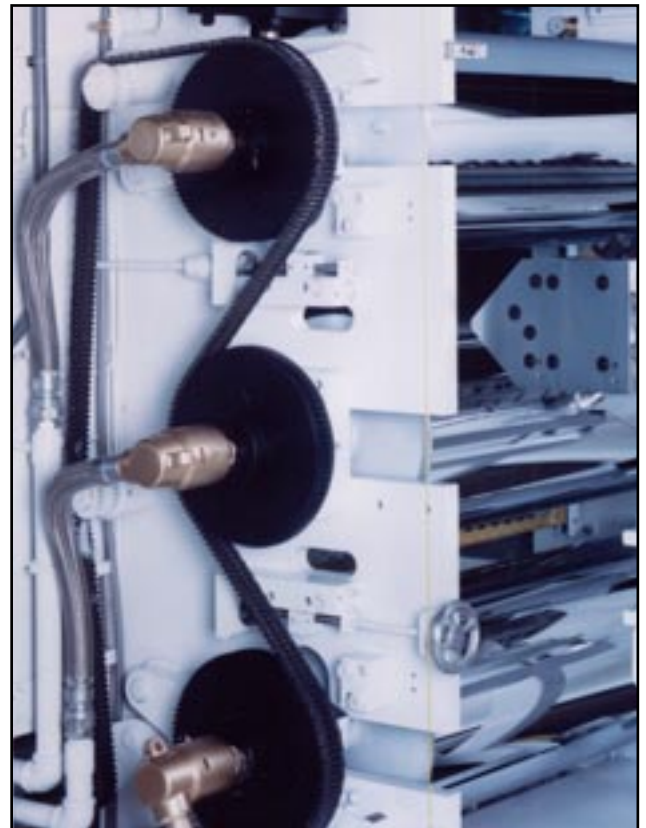

Rampower Duplex in Plastic Manufacturing Equipment

FOR 1/2" PITCH RAMPOWER AND ALL PITCHES OF SC DUPLEX



Bring the ends of the chain together so the holes are aligned



Insert longer pin through the chain



Insert short pin so convex pin surfaces are in contact



Install spirol roll pin

FOR 3/4" PITCH RAMPOWER AND ALL PITCHES OF RAMFLEX



Bring the ends of the chain together so the holes are aligned



Insert longer pin through the chain



Insert short pin so convex pin surfaces are in contact



Put washer on pin and install cotter or spirol roll pin

Service Factors

Service factors are used during drive selection to compensate for less than optimum drive conditions. The chain width formulas on page 10 are based on the following drive conditions:

- * Power source = electric motor, hydraulic motor, turbine, or engine with fluid coupling
- * Proper lubrication

For conditions that differ from those listed above, the power to be transmitted must be multiplied by a service factor to obtain the design power.

The design power is then used to calculate the required chain width.

Select an appropriate service factor from the service factor table, then add one or more of the additional factors listed here:

- Fixed center distance = 0.2
- Engine with mechanical coupling = 0.2
- Inadequate lubrication = 0.2 to 0.5

SERVICE FACTOR TABLE

AGITATORS (paddle or propeller)		DREDGES		Draw works	1.8
Pure liquid	1.1	Conveyors, cable reels	1.4	Chillers, Paraffin filter presses, Kilns	1.5
Liquids (variable density)	1.2	Jigs, screens	1.6	PAPER INDUSTRY MACHINERY	
BAKERY MACHINERY		Cutter head drives	Consult Ramsey	Agitators, bleachers	1.1
Dough Mixer	1.2	Dredge pumps	1.6	Barker(mechanical)	1.6
BLOWERS	See Fans	FANS & BLOWERS		Beater, Yankee Dryer	1.3
BREWING & DISTILLING EQUIPMENT		Centrifugal, propeller, vane	1.3	Calendars, Dryer, Paper Machines	1.2
Bottling Machinery	1.0	Positive blowers (lobe)	1.5	Chippers, winder drums	1.5
Brew Kettles, cookers, mash tubs	1.0	GRAIN MILL MACHINERY		PRINTING MACHINERY	
Scale Hopper (Frequent starts)	1.2	Sifters, purifiers, separators	1.1	Embossing, flat bed presses, folders	1.2
BRICK & CLAY EQUIPMENT		Grinders, hammer mills	1.2	Paper cutter, rotary press, linotype	1.1
Auger machines, cutting table	1.3	Roller mills	1.3	Magazine, Newspaper Presses	1.5
Brick machines, dry press, granulator	1.4	GENERATORS & EXCITERS	1.2	PUMPS	
Mixer, pug mill, rolls	1.4	ICE MACHINES	1.5	Centrifugal, gear, lobe, vane	1.2
CEMENT PLANTS		LAUNDRY MACHINERY		Dredge	1.6
Kilns	1.4	Dampeners, Washers	1.1	Pipe line	1.4
CENTRIFUGES	1.4	Tumblers	1.2	Reciprocating (3 or more cyl.)	1.3
COMPRESSORS		MACHINE TOOLS		Reciprocating (1 or 2 cyl.)	1.6
Centrifugal, rotary (lobe)	1.1	Grinders, lathes, drill press	1.0	RUBBER & PLASTICS EQUIPMENT	
Reciprocating (1 or 2 cyl.)	1.6	Boring mills, milling machines	1.1	Calendars, rolls, tubers	
Reciprocating (3 or more cyl.)	1.3	MARINE DRIVES	Consult Ramsey	Tire-building, Banbury Mills	1.5
CONSTRUCTION EQUIPMENT		MILLS		Mixers, sheeters	1.6
OR OFF-HIGHWAY VEHICLES		Rotary type:		Extruders	1.5
Drive line , power take-off	Consult Ramsey	Ball, Pebble, Rod, Tube, Roller	1.5	SCREENS	
Accessory drives		Dryers, Kilns, tumbling barrels	1.6	Conical, revolving	1.2
CONVEYORS		Metal type:		Rotary, gravel, stone, vibrating	1.5
Apron, bucket, pan, elevator	1.4	Draw bench carriage, main drive	1.5	STOKERS	1.1
Belt (ore, coal, sand, salt)	1.2	FORMING MACHINES	Consult Ramsey	DYNAMOMETERS	Consult Ramsey
Belt (light packages, oven)	1.0	MIXERS		TEXTILE INDUSTRY	
Screw, flight (heavy duty)	1.6	Concrete	1.6	Spinning frames, twisters, Wrappers	1.0
CRANES & HOISTS		Liquid, Semi-liquid	1.1	Batchers, calendars, looms	1.1
Main hoist (medium duty)	1.2	OIL INDUSTRY MACHINERY			
Main hoist (heavy duty), skip hoist	1.4	Compounding Units	1.1		
CRUSHING MACHINERY		Pipe line pumps	1.4		
Ball mills, crushing rolls, jaw crushers	1.6	Slush pumps	1.5		

Drive Maintenance

INSPECTION

Periodic drive inspection and adjustment will often result in increased service life and lower costs. An inspection should include sprocket alignment, tension, lubrication, and the general condition of chain and sprockets.

TENSIONING AND ELONGATION

As a chain wears, its pitch will elongate and the chain will wrap an increasingly larger pitch circle. Re-tensioning of the chain will normally eliminate problems associated with excess chain slack. Also, with Ramsey chains this elongation occurs uniformly throughout the length of the chain so efficient, smooth operation is maintained.

However, when elongation becomes excessive the chain can skip teeth and damage the sprocket. It is best to replace the chain before this happens. The size of the large sprocket will limit the allowable elongation of the chain. In general, a chain will not properly wrap sprockets when it has elongated by $200/N\%$ where N = the number of teeth in the larger sprocket. Other application related considerations may further limit the amount of acceptable elongation.

ALIGNMENT

Sprocket alignment must be maintained for optimum drive performance and chain life. Examine the sides of the chain guide links for excessive wear or gouging; these are often symptoms of misaligned sprockets.

Periodically check that sprockets are securely fastened. If sprocket position has changed since installation go through the alignment procedure used during installation.

ENGINEERING FORMULAS

p = pitch in inches
 Z = number of teeth in sprocket
 V = chain speed in feet per minute
 W = power in horsepower
 N = revolutions per minute
 P_d = pitch diameter in inches
 L = working load in pounds
 T = torque in inch pounds

$$W = \frac{TN}{63,025}$$

$$L = \frac{396,000W}{pZN}$$

$$T = \frac{LP_d}{2}$$

$$W = \frac{VL}{33,000}$$

$$L = \frac{33,000W}{V}$$

$$T = \frac{63,025W}{N}$$

$$P_d = \frac{p}{\sin(180/Z)}$$

$$V = \frac{pZN}{12}$$

Ramsey Products Corporation
P.O. Box 668827
Charlotte, NC 28266-8827
Ship To: 135 Performance Drive
Belmont, NC 28012
Tel: (704) 394-0322
Fax: (704) 394-9134
www.ramseychain.com
sales@ramseychain.com



Ramsey Europe
Germany
Tel: +49 151 24042790
Great Britain
Tel: +44 (0) 7824 814116
euro.sales@ramseychain.com