

Ramsey Conveying Chains



For Industrial Conveying



MEETING THE CHALLENGES OF INDUSTRIAL CONVEYING

Ramsey Products designs and manufactures silent or “inverted tooth” chains and sprockets to meet the challenges inherent in transporting industrial products. We offer an extensive line of standard silent chains, custom-designed chains, as well as replacements for most competitors’ products. For more than 95 years, Ramsey has focused on silent chain products. Today, we remain committed to providing our customers with the world’s widest range of top quality products, competitive pricing, and unparalleled service. If a job can be done with silent chain, we will find the best chain for the job, at the lowest possible cost.

WHY SILENT CHAIN?

For companies that require conveying, silent chains offer many benefits in applications with large temperature ranges, precision inspection and measurement. Ramsey silent conveyor chains are designed and built specifically for these environments.

DURABILITY

Our chains are made from through-hardened steel link plates and case hardened steel pins. Chain designs and materials are chosen to meet the demanding conditions encountered on the production floor. Long service life and minimal maintenance helps you minimize costly downtime for conveyor chain replacement.

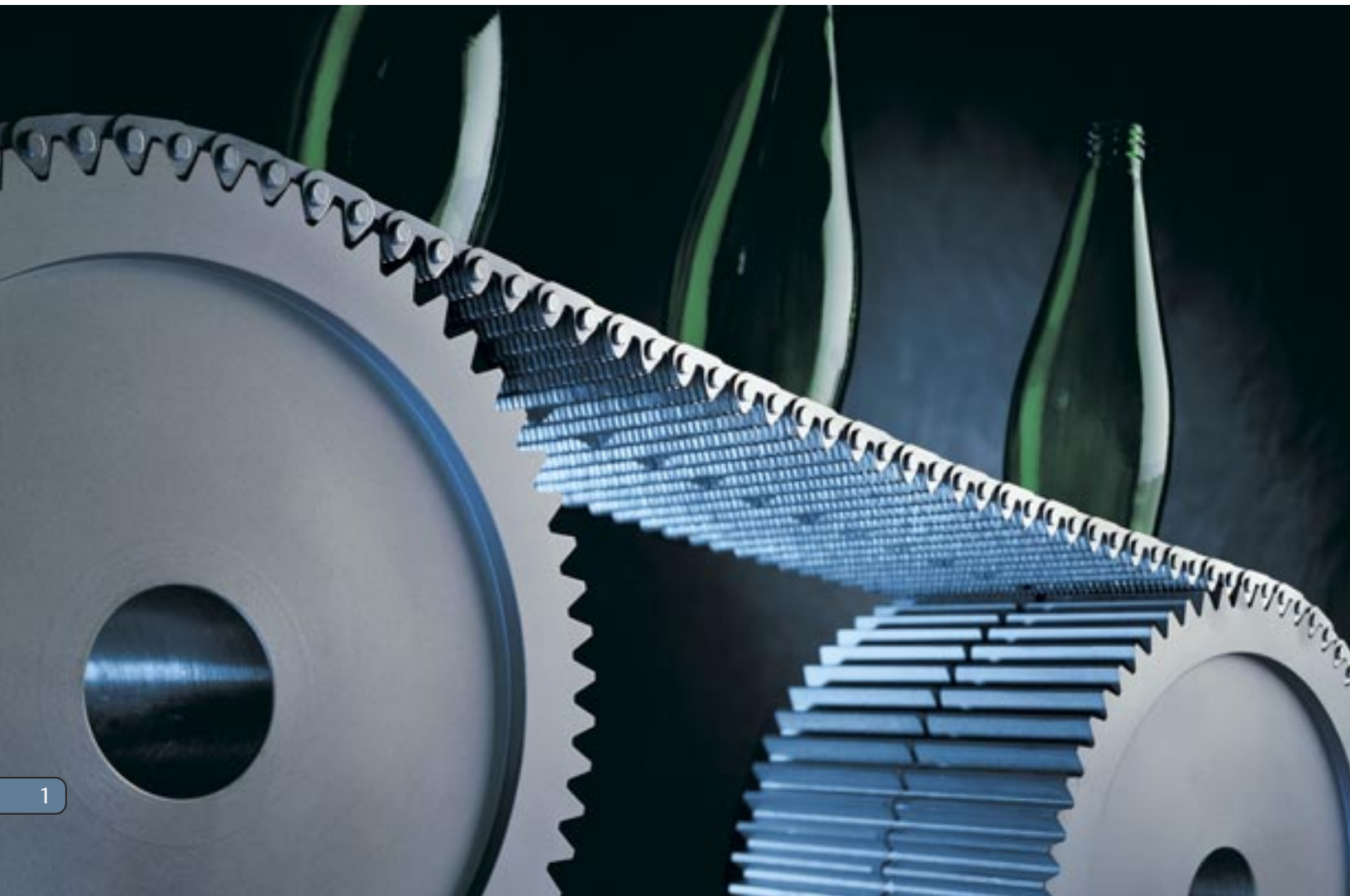

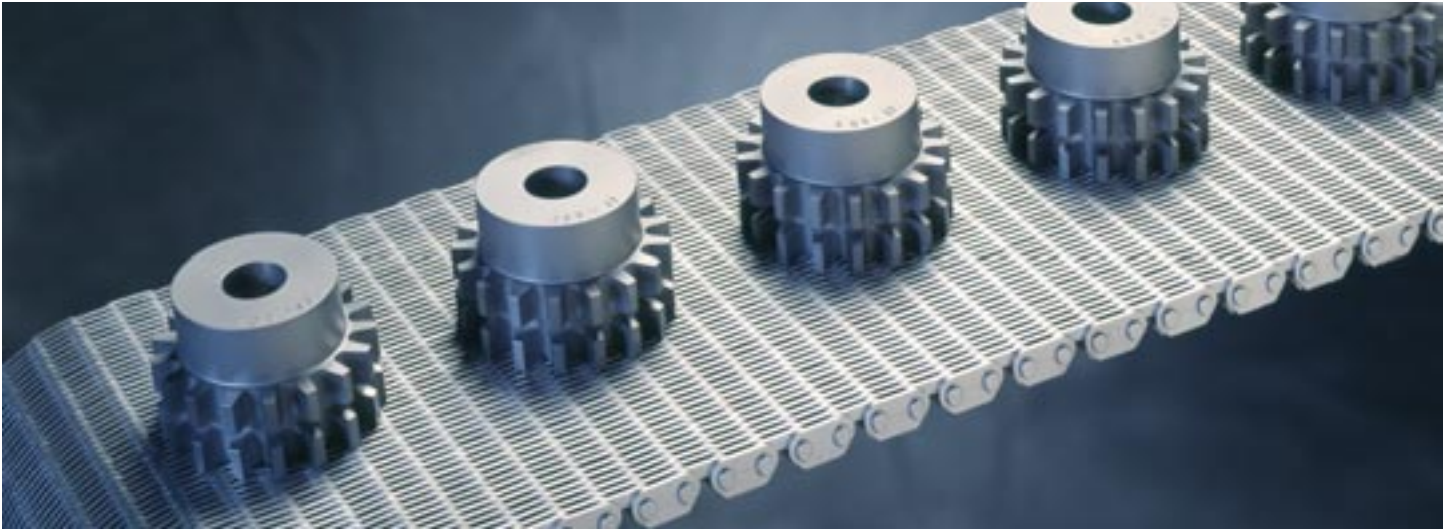

FLATNESS AND UNIFORMITY

The flat uniform surface of Ramsey chain provides trouble-free transport of even the smallest products. Consistent chain height allows items to be smoothly transferred on and off the conveyor, reducing problems caused by improper product feeding and moving. For the ultimate in smooth transport, the chain surface can be ground.

NEARLY CONSTANT SURFACE VELOCITY

Ramsey carefully controls chain pitch and lot uniformity during chain manufacture to ensure consistent chain surface velocity throughout the conveyor. Uniform velocity reduces problems associated with irregular spacing and misfeeds. Also, as the chain wears, the pitch increases uniformly throughout the chain, and velocity remains constant.

HEAT RESISTANT

We manufacture our chain from hardened steel components to withstand high temperatures. Heat transfer from transported products does not affect the uniformity of the conveyor surface.

ECONOMIC

Because it lasts for years, improves product handling, and requires little or no maintenance, Ramsey chain provides a cost-effective means for conveying products in high-speed production lines. The right chain can help reduce problems and machine downtime.

COMPONENTS

A Ramsey inverted tooth chain drive consists of a chain and two or more 1/2" pitch sprockets to drive and guide the chain. Chain is available in a wide variety of types and assemblies. Depending on the type, a chain contains some or all of the following component parts:

DRIVING LINKS: Driving links, also known as plain links, engage with sprocket teeth to drive the chain. They are typically the most common component in the chain.



GUIDE LINKS: Guide links maintain proper tracking of the chain on sprockets. They can be positioned on the outer edges of the chain in side guide and multiguide chain or in the center, with center guide chain.



SPACERS: Spacers are often placed between link plates in order to reduce chain weight and thermal mass, lessen the resistance to air flow through the chain, and allow the passage of debris.



PINS: Pins allow the chain joint to flex and hold the assembled chain together. Chains may have a single pin in each joint or two pins, depending on the chain type.

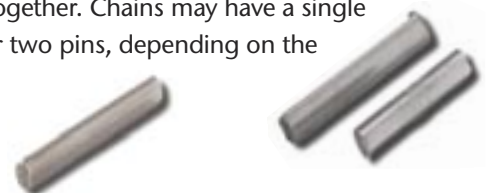

TRADITIONAL SILENT CHAINS

ULTRALIFE CONVEYOR SERIES

UltraLife, one of Ramsey's best quality conveyor chains, was designed in cooperation with major manufacturers for high-speed production lines and field tested in plants around the world. UltraLife chain has been proven to last longer than any other conveyor chain we have tested.

The improved performance of UltraLife is the result of Ramsey's proprietary link and chain production techniques. These techniques produce driving links that are flat and uniform, with straight-edged, burr-free apertures.

The straight edge of the aperture maximizes the link area contacting the pins and reduces joint bearing stresses and wear. Process controls throughout component manufacture and chain assembly ensure consistent chain pitch and quality. Consistent pitch results in very little fluctuation in chain velocity and uniform wear throughout the life of the chain.

ULTRALIFE - 1/2" PITCH

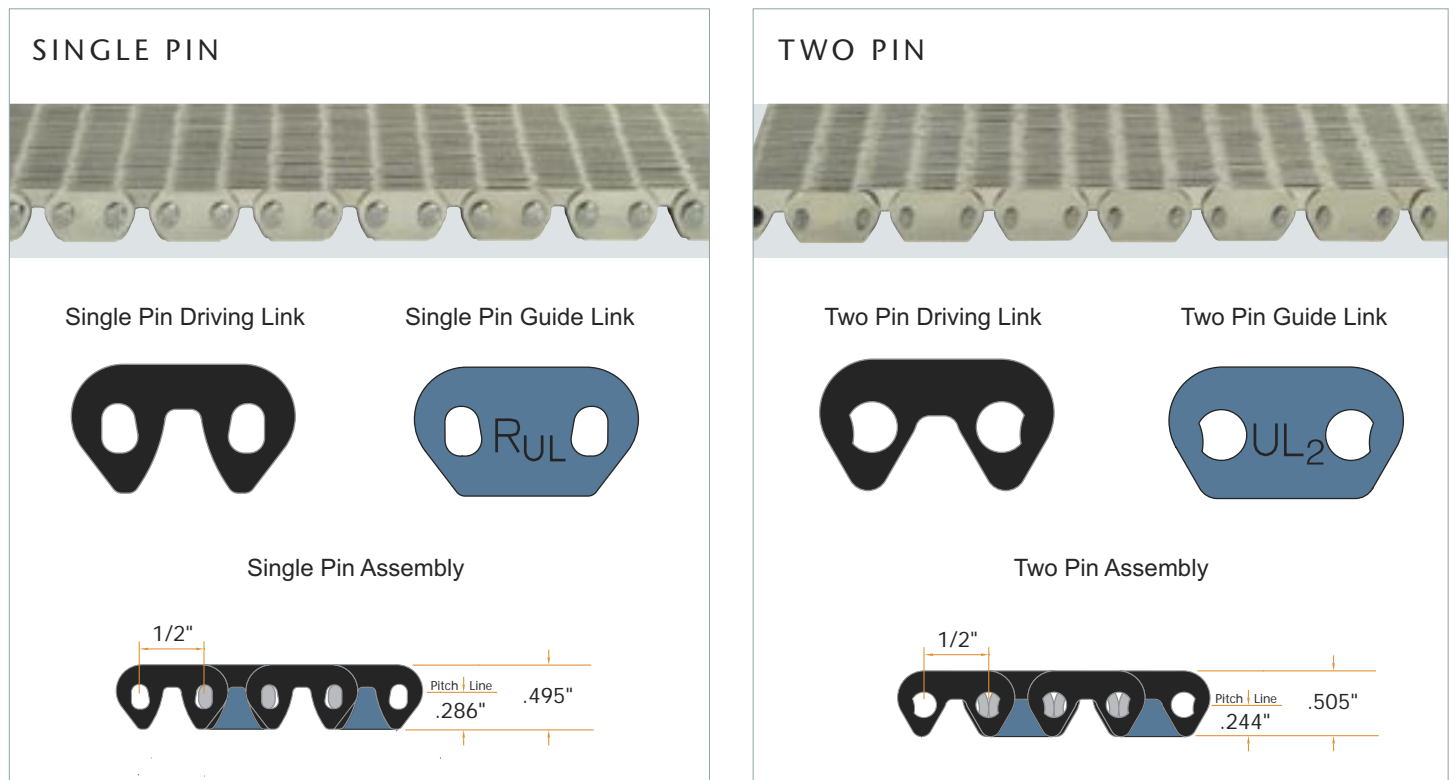

ULTRALIFE - 1" EXTENDED PITCH

Extended pitch conveyor chain was developed in cooperation with industry engineers looking for a lightweight, long-lasting chain that would operate on existing 1/2" pitch sprockets. The resulting 1" pitch chain has less mass than a comparable width standard conveyor. With fewer joints per foot, it is also less susceptible to joint fouling and wear.

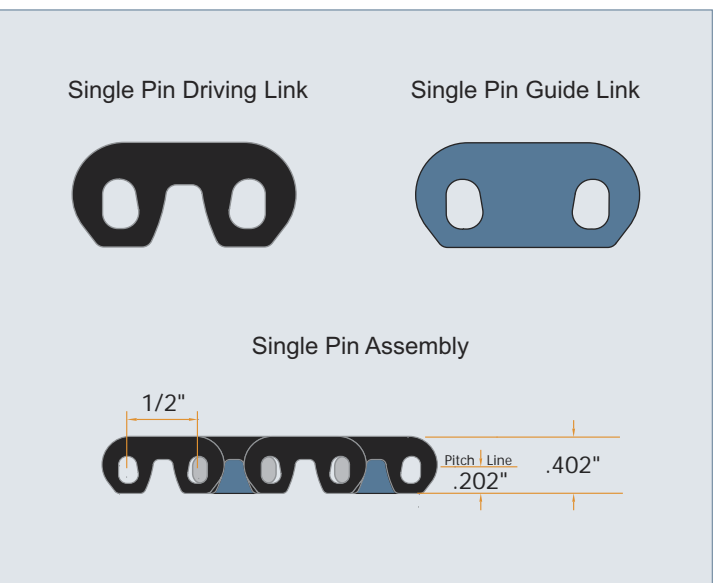
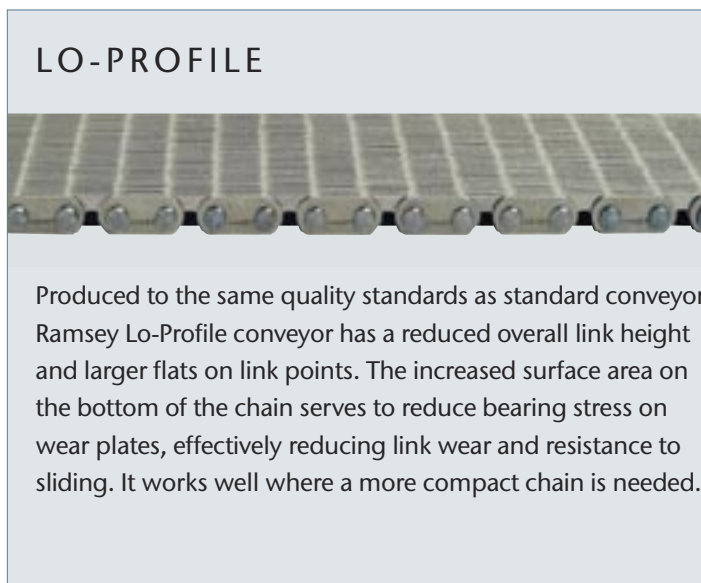
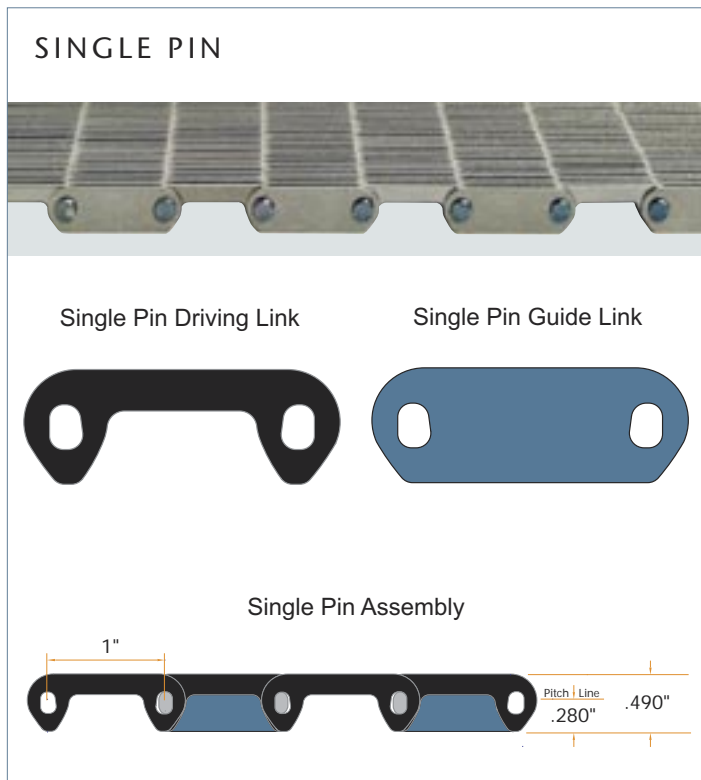

WEAR PROTECTED CHAINS

Typical chains contain exposed pin heads that can snag or hang up on protruding edges along the conveyor's path. This snagging can lead to the chipping or shearing away of the pin head, conveyor surging, and product flow disruption. Ramsey Wear Protected Chains are made with special wear protected side links that fully enclose pin heads guarding them against pin wear and chipping. This allows the chain to be operated in direct contact with lateral guides or transfer plates, eliminating gaps that can prevent smooth product transfer.

LIFEGUARD

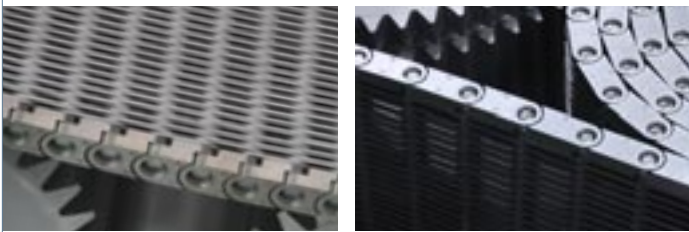

Available in 1/2" (left) or 1" pitch (right)

PATENTED IN THE USA AND EUROPE

Ramsey's Lifeguard Wear Protected conveying chains are designed to prolong chain life by guarding exposed pin heads against wear and by preventing chain snagging. In addition, Lifeguard's special interlocking side links not only guard against pin head wear, but also greatly reduce the size of gaps between adjacent side plates. With smaller gaps between the links, the potential for snagging on lateral guides is significantly reduced.

SENTRY

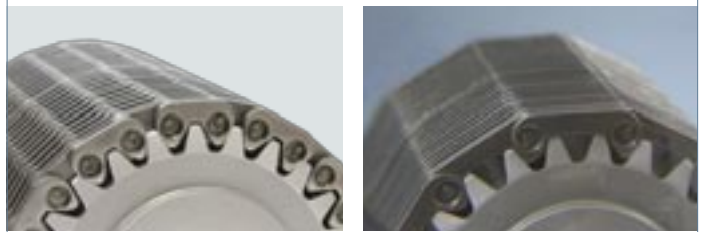

Available in 1/2" (left) or 1" pitch (right)

Ramsey's Sentry chains combine wear protection, two pin chain design with the best qualities of Ramsey's high speed power transmission chains. Sentry chains feature:

- Guard Links with Fully Recessed Pin Heads
- 100% Hardened Alloy Steel Construction- No Sintered Metal
- Two Pin Chain Joints
- Staked Pin Heads
- Pre-Stressing for Reduced Chain Elongation

RAMSEY ALL-STEEL

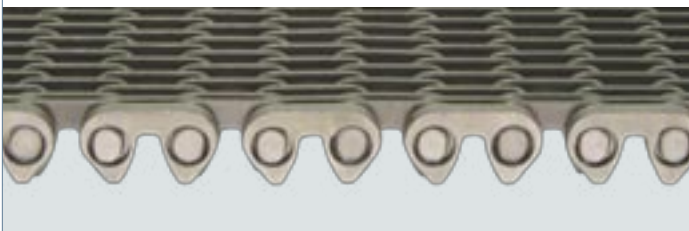

Available in 1/2" and 1" pitch, Side Guide, Center Guide, or Multiguide

Ramsey's 100% steel chains are tough enough for the most demanding applications. Protected against lateral chain and pin head wear by all steel, hardened, alloy side links, the links in this chain will never crack under pressure. Ramsey All-Steel chains are available in 1/2" and 1" pitch and chain widths range from less than 1 inch to over 20 inches.

ALLGUARD FX



Available in 1/2" pitch, Side Guide or Multiguide

Ramsey's Allguard FX conveyor chains are designed to extend chain life and improve product handling. Allguard FX side links fully enclose pin heads and guard against pin wear and chipping. This allows Allguard FX chains to run in direct contact with lateral guides, immune to the pin head wear that can destroy typical chains.

SPECIAL APPLICATION CHAINS

STAINLESS STEEL



Available in 1/2" or 1" pitch (above)

Most Ramsey chains are available in stainless steel. Typically, links are made from 316 and 420 stainless steel and pins are made from a wear resistant, hardenable grade of stainless or carbon steel. With compatible stainless steel sprockets, these chains are capable of intermittent temperatures up to 1200°F (650°C). Stainless steel chains also offer superior corrosion resistance. They provide a tolerance to chemicals and atmospheres which are unsuitable for carbon steel chains.

R-SELECT



Available in 1/2" (above) or 1" pitch

R-Select chains put hardened, highly wear resistant chromium alloy links in the parts of the chain which are expected to wear the most. Other parts of the chain, which are less subject to wear, are made with standard, heat treated steel links. Because, the chain is not made entirely of the more costly wear resistant links, the overall cost of the chain can be as little as 20% more than the cost of a standard chain. Alternatively, those customers looking for optimum wear characteristics, and are less concerned about the added cost, can have chains made entirely from wear resistant alloy links.

RKO TOOL

The RKO Tool, or "Ramsey Knock Out" Tool, greatly simplifies connecting and disconnecting all Ramsey conveying chains which use a single pin joint. The tool is especially beneficial with wear protected chains, including Allguard, Lifeguard, and All-Steel chains.

Three Distinct Work Stations:

- First station uses a ram screw to remove the pin head.
- Second station maintains link alignment and allows pin removal or new pin insertion.
- Third station provides for insertion of drive pin chain connector.

Note: Optional drive pin connectors must be purchased separately.



SPECIFYING A CHAIN

IDENTIFYING YOUR CONVEYOR CHAIN

When specifying an inverted tooth chain, you must consider appropriate guide type, build type and joint type. Ramsey uses a four-part numbering system for identifying conveyor assemblies. When ordering, simply provide the appropriate Assembly Number for easy chain identification.

ASSEMBLY NUMBER

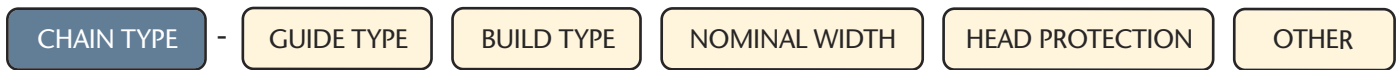

EXAMPLE

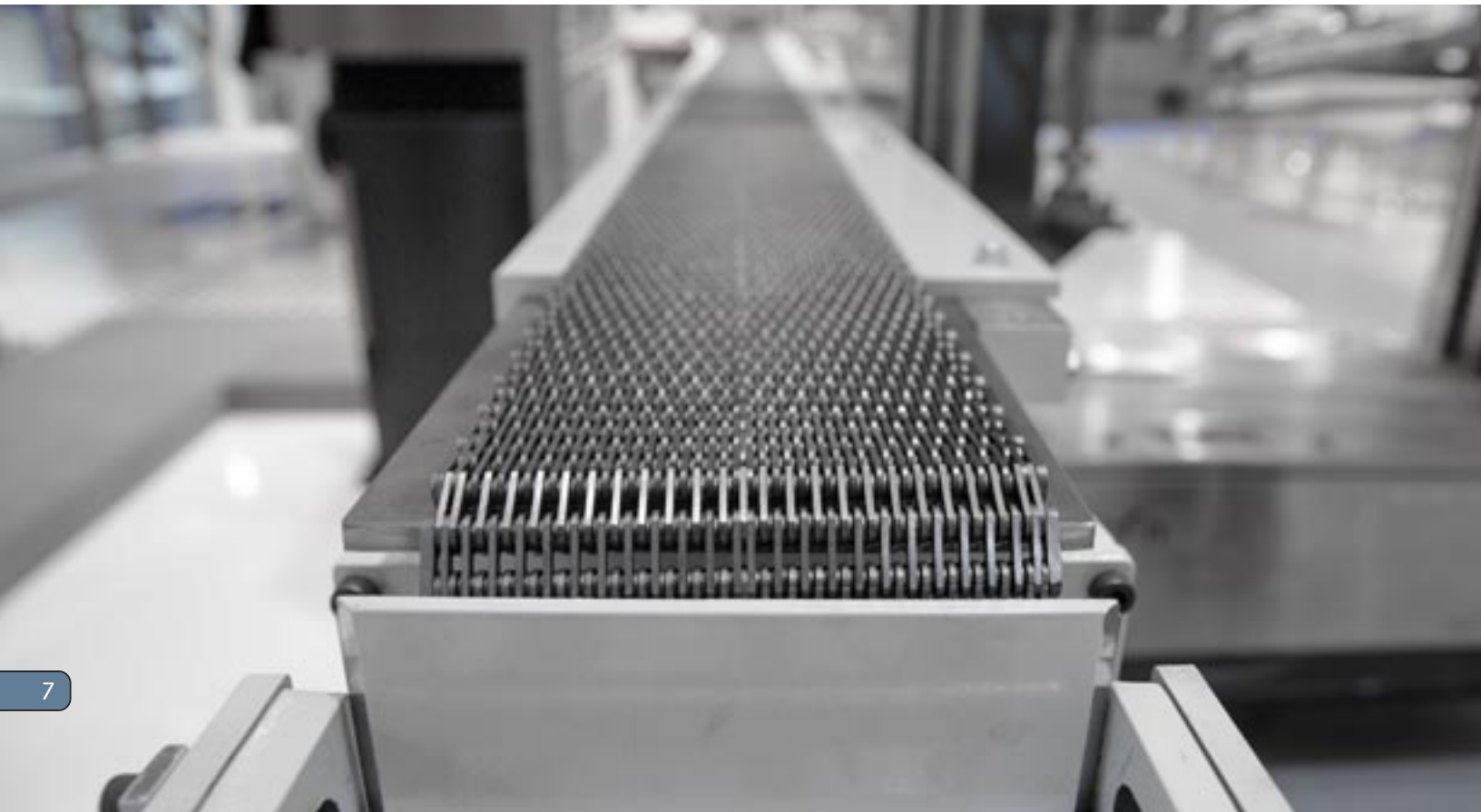
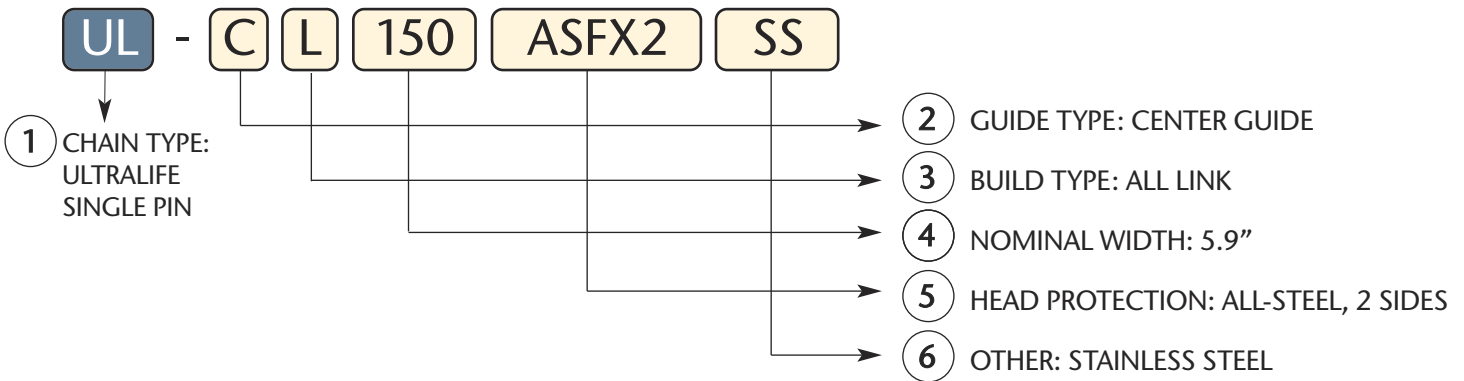

1 CHAIN TYPE

- UL = Ultralife Single Pin
- UL2 = Ultralife Two Pin
- ULEP = Ultralife Extended Pitch, Single Pin
- ULEP2 = Ultralife Extended Pitch, Two Pin
- LP = Lo-Profile

2 GUIDE TYPE

- C = Center Guide
- S = Side Guide
- M = Multiguide

3 BUILD TYPE

- L = All-Link
- S = Link-Spacer

4 NOMINAL WIDTH

Specify nominal width in inches.

5 HEAD PROTECTION

- AGFX2 = Allguard FX Powdered Metal, Head Protection on both sides
- ASFX2 = All-Steel, Head Protection on both sides
- AGLG2 = Lifeguard, Head Protection on both sides

Note that there are many chain widths and assemblies not included in this brochure.

From time to time, our customers need a chain that is different from our typical specifications. We are set up to make custom orders efficiently and cost-effectively, and we welcome such inquiries.

6 OTHER CHAIN OPTIONS

DOUBLE LACING

- DL = Double Laced, Full chain width
- DLC_ _ _ = Double Laced, Center Section, Width to specification in inches

Double laced chains are configured for strength with a greater load bearing surface while offering excellent air flow. Double link chains provide a high level of bottle stability and long life.

STAINLESS STEEL

- SS = Stainless Steel

Most Ramsey chains are available in either 316 and 420 stainless steel. Pins are made from a wear resistant, hardened grade of stainless.

CHAIN GRINDING

- GT = Ground Top
- GTB = Ground Top & Bottom

To achieve an ultra-smooth surface Ramsey can grind the top, bottom, or both sides of a chain to the customer's desired dimensions. To order, simply specify the chain type and assembly number and include your grinding requirements. It is important to specify the amount of material to be ground off each surface and the desired finished dimensions of the chain.

Note: The minimum amount of grinding required to "clean up" a surface is 0.004" to 0.006". The standard tolerance on grinding is 0.001".

SPECIAL HEAD PROTECTED CHAINS

SENTRY CHAINS

Sentry chain part numbers do not follow the standard part number structure. Sentry chains are manufactured specific to customer requirements.

R-SELECT CHAINS

R-Select chain part numbers do not follow the standard part number structure. R-Select chains are manufactured specific to customer requirements.

CHAIN JOINT TYPE

When choosing a chain type, note that Ramsey chains are available in two distinct joint types:

Single Pin and Two Pin

In some applications one joint type may provide distinct advantages over the other. However, in many cases, either joint type will provide satisfactory results and it is simply a matter of customer preference.



Single pin joints provide a durable, smooth acting joint, satisfactory life, and are more easily installed than two pin joints. Ramsey's single pin joint was developed specifically for the glass industry, and is the joint type most commonly used in glass conveyor chain.



Two pin joints were originally developed for use in power transmission chains and have been adapted for use in conveying chains. They offer many of the same advantages in conveyor chain as in transmission chain, including low friction, high efficiency, and long life.

GUIDE TYPE

Ramsey chains are available in the following guide types:

Center Guide, Side Guide and Multiguide

Remember that sprocket guide type must be compatible with your chain.

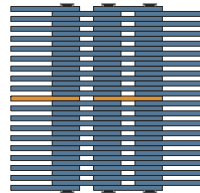

Center Guide (c) Guide links in the center of the chain align with a groove in the center of the sprocket.

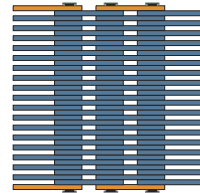

Side Guide (s) Guide links are on the outer edges of the chain and sprockets fit between them.

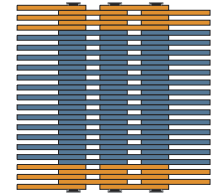

Multiguide (m) Multiple guide links on the chain's outer edge surround the sprocket and provide increased area for chain support on a wear strip.

BUILD TYPE

Inverted tooth conveyor chains are available in two basic build types:

All-Link and Link-Spacer

When replacing a chain, we usually recommend that you select the build that has been used successfully at your company in the past.

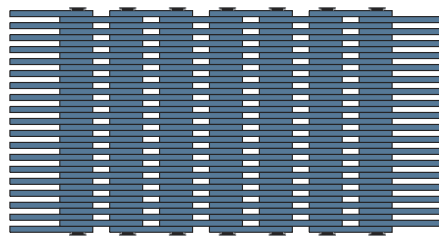

All-Link (l) Composed entirely of links, all-link chain provides maximum surface area and is often preferred for transporting small glassware. All-Link chain has the greatest thermal mass and the smallest inter-link air spaces, so it provides the greatest resistance to induced heating or cooling.

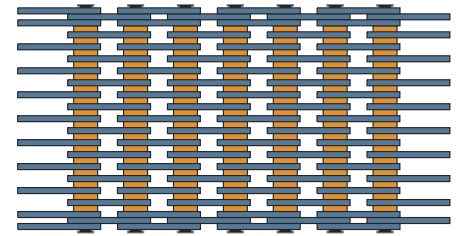

Link-Spacer (s) In this assembly type, spacers are placed between link plates to decrease weight, reduce surface area and increase airflow through the chain. Larger inter-link air spaces also allow passage of debris through the chain.

ORDERING CHARTS

ASSEMBLIES FOR ULTRALIFE, ULTRALIFE EXTENDED PITCH AND LO-PROFILE
DIMENSIONS SHOWN ARE FOR 1/2" PITCH, OTHER PITCHES ARE AVAILABLE

GUIDE TYPE: CENTER GUIDE CHAIN

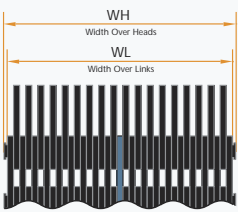
ALL-LINK ASSEMBLY					SINGLE PIN		TWO PIN	
	ASSEMBLY NUMBER	NOMINAL WIDTH INCHES	WL (MAX) INCHES	SPROCKET* WIDTH INCHES	WH (MAX) INCHES	WEIGHT LB/FT	WH (MAX) INCHES	WEIGHT LB/FT
	CL025	1	0.93	1	1.07	1	1.03	1
	CL040	1.5	1.46	1.5	1.54	1.5	1.55	1.5
	CL050	2	1.93	2	2.07	2	2.03	2
	CL075	3	2.92	3	3.06	3	3.02	3
	CL100	4	3.58	3.94	3.74	3.5	3.7	3.7
	CL120	4.75	4.57	4.72	4.72	4.4	4.69	4.7
	CL125	5	4.80	4.92	4.96	4.7	4.92	5
	CL140	5.5	5.31	5.51	5.47	5.2	5.43	5.5
	CL150	6	5.79	5.91	5.94	5.7	5.91	6.1
	CL180	7	6.89	7.09	7.05	6.8	7.01	7.3
	CL200	8	7.83	7.87	7.99	7.7	7.95	8.2
	CL250	10	9.84	9.84	10	9.7	9.96	10.4
	CL300	12	11.81	11.81	11.97	11.6	11.93	12.4

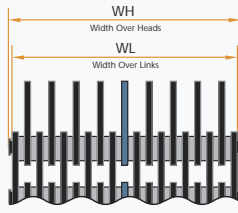
LINK-SPACER ASSEMBLY					SINGLE PIN		TWO PIN	
	ASSEMBLY NUMBER	NOMINAL WIDTH INCHES	WL (MAX) INCHES	SPROCKET* WIDTH INCHES	WH (MAX) INCHES	WEIGHT LB/FT	WH (MAX) INCHES	WEIGHT LB/FT
	CS025	1	0.93	1	1.07	0.8	1.03	0.8
	CS040	1.5	1.43	1.5	1.57	1.2	1.55	1.2
	CS050	2	1.93	2	2.07	1.5	2.03	1.5
	CS075	3	2.92	3	3.06	2.2	3.02	2.3
	CS100	4	3.58	3.94	3.74	2.4	3.7	2.5
	CS120	4.75	4.57	4.72	4.72	3	4.69	3.2
	CS125	5	4.80	4.92	4.96	3.2	4.92	3.3
	CS140	5.5	5.31	5.51	5.47	3.5	5.43	3.7
	CS150	6	5.79	5.91	5.94	3.8	5.91	4
	CS180	7	6.89	7.09	7.05	4.5	7.01	4.8
	CS200	8	7.83	7.87	7.99	5.1	7.95	5.4
	CS250	10	9.84	9.84	10.00	6.5	9.96	6.8
	CS300	12	11.81	11.81	11.97	7.7	11.93	8.1

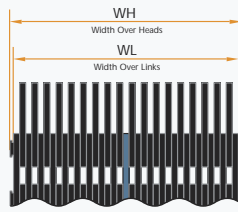
ALL-LINK ASSEMBLY, EXTENDED PITCH						
	ASSEMBLY NUMBER	NOMINAL WIDTH INCHES	WH (MAX) INCHES	WL (MAX) INCHES	SPROCKET* WIDTH INCHES	WEIGHT LB/FT
	CL025	1	1.10	1	1	0.7
	CL040	1.5	1.47	1.37	1.50	0.9
	CL050	2	2.03	1.93	2	1.3
	CL075	3	3.16	3.06	3	2
	CL100	4	3.77	3.62	3.94	2.2
	CL125	5	4.98	4.84	4.92	3
	CL140	5.5	5.45	5.31	5.51	3.2
	CL150	6	5.92	5.78	5.91	3.5
	CL200	8	7.85	7.72	7.87	4.8
	CL300	12	11.98	11.83	11.81	7.2

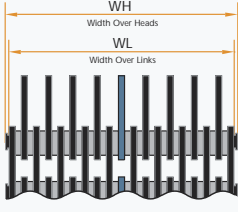
LINK-SPACER ASSEMBLY, EXTENDED PITCH						
	ASSEMBLY NUMBER	NOMINAL WIDTH INCHES	WH (MAX) INCHES	WL (MAX) INCHES	SPROCKET* WIDTH INCHES	WEIGHT LB/FT
	CS025	1	1.19	1.05	1	0.6
	CS040	1.5	1.62	1.48	1.50	0.8
	CS050	2	2.11	1.97	2	1.1
	CS075	3	3.15	3.01	3	1.5
	CS100	4	3.77	3.62	3.94	1.6
	CS125	5	4.98	4.84	4.94	2.2
	CS140	5.5	5.45	5.31	5.51	2.4
	CS150	6	5.92	5.78	5.91	2.6
	CS200	8	7.85	7.72	7.87	3.4
	CS300	12	11.98	11.83	11.81	5.1

* +0.0/-2.0% Tolerance

ORDERING CHARTS

GUIDE TYPE: SIDE GUIDE CHAIN

ALL-LINK ASSEMBLY

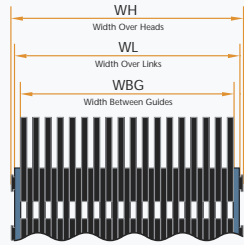

ASSEMBLY NUMBER	NOMINAL WIDTH INCHES	WL (MAX) INCHES	WBG (MIN) INCHES	SPROCKET* WIDTH INCHES	WH (MAX) INCHES	WEIGHT LB/FT	WH (MAX) INCHES	WEIGHT LB/FT
SL025	1	0.89	0.77	0.71	1.07	1	1.03	1
SL040	1.5	1.58	1.49	1.43	1.78	1.5	1.78	1.5
SL050	2	1.83	1.71	1.65	2.07	2	2.03	2
SL075	3	2.78	2.66	2.6	3.06	3	3.02	3
SL100	4	4.02	3.91	3.85	4.17	4.1	4.17	4.4
SL120	4.75	4.54	4.42	4.36	4.68	4.6	4.68	4.9
SL125	5	5.07	4.95	4.89	5.21	5	5.21	5.4
SL140	5.5	5.46	5.34	5.28	5.61	5.5	5.6	5.9
SL150	6	6.02	5.9	5.84	6.16	6	6.16	6.5
SL180	7	6.87	6.75	6.69	7.04	6.9	7.04	7.3
SL200	8	7.98	7.86	7.8	8.13	8	8.12	8.6
SL250	10	10.08	9.96	9.91	10.23	10.1	10.22	10.9
SL300	12	11.94	11.82	11.76	12.09	12	12.08	12.8

SINGLE PIN

TWO PIN

LINK-SPACER ASSEMBLY

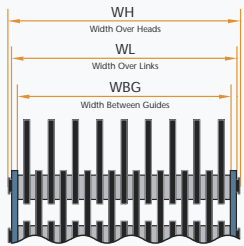

ASSEMBLY NUMBER	NOMINAL WIDTH INCHES	WL (MAX) INCHES	WBG (MIN) INCHES	SPROCKET* WIDTH INCHES	WH (MAX) INCHES	WEIGHT LB/FT	WH (MAX) INCHES	WEIGHT LB/FT
SS025	1	0.89	0.77	0.71	1.07	0.8	1.03	0.8
SS040	1.5	1.58	1.49	1.43	1.78	1.2	1.78	1.2
SS050	2	1.83	1.71	1.65	2.07	1.5	2.03	1.5
SS075	3	2.78	2.66	2.6	3.06	2.2	3.02	2.3
SS100	4	4.02	3.91	3.85	4.17	2.7	4.17	2.9
SS120	4.75	4.54	4.42	4.36	4.68	3	4.68	3.2
SS125	5	5.07	4.95	4.89	5.21	3.4	5.21	3.6
SS140	5.5	5.46	5.34	5.28	5.61	3.64	5.60	3.9
SS150	6	6.02	5.9	5.84	6.16	4	6.16	4.2
SS180	7	6.87	6.75	6.69	7.04	4.5	7.04	4.8
SS200	8	7.98	7.89	7.8	8.13	5.2	8.12	5.6
SS250	10	10.08	9.96	9.91	10.23	6.7	10.22	7.1
SS300	12	11.94	11.82	11.76	12.09	7.8	12.08	8.3

SINGLE PIN

TWO PIN

ALL-LINK ASSEMBLY, EXTENDED PITCH

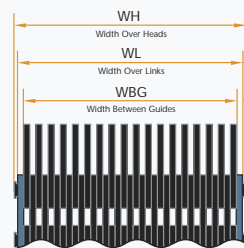

ASSEMBLY NUMBER	NOMINAL WIDTH INCHES	WH (MAX) INCHES	WL (MAX) INCHES	WBG (MIN) INCHES	SPROCKET* WIDTH INCHES	WEIGHT LB/FT
SLO25	1	1.11	0.93	0.81	0.75	0.7
SLO40	1.5	1.67	1.53	1.41	1.35	0.9
SLO50	2	2.04	1.90	1.78	1.72	1.3
SLO75	3	3.16	3.02	2.90	2.84	2.0
SL100	4	4.17	4.02	3.91	3.85	2.6
SL125	5	5.21	5.07	4.95	4.89	3.2
SL140	5.5	5.61	5.46	5.34	5.28	3.4
SL150	6	6.16	6.02	5.90	5.84	3.8
SL200	8	7.94	7.75	7.66	7.60	4.8
SL300	12	12.09	11.94	11.82	11.76	7.4

LINK-SPACER ASSEMBLY, EXTENDED PITCH

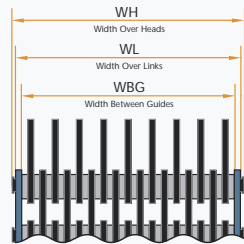

ASSEMBLY NUMBER	NOMINAL WIDTH INCHES	WH (MAX) INCHES	WL (MAX) INCHES	WBG (MIN) INCHES	SPROCKET* WIDTH INCHES	WEIGHT LB/FT
SS025	1	1.09	0.91	0.79	0.73	0.6
SS040	1.5	1.60	1.40	1.28	1.22	0.8
SS050	2	2.20	1.98	1.86	1.80	1.1
SS075	3	3.12	2.86	2.74	2.68	1.5
SS100	4	4.17	4.02	3.91	3.85	1.7
SS125	5	5.21	5.07	4.95	4.89	2.2
SS140	5.5	5.61	5.46	5.34	5.28	2.3
SS150	6	6.04	5.89	5.78	5.72	2.7
SS200	8	7.94	7.75	7.66	7.60	3.3
SS300	12	12.09	11.94	11.82	11.76	4.8

GUIDE TYPE: MULTIGUIDE CHAIN

ALL-LINK ASSEMBLY

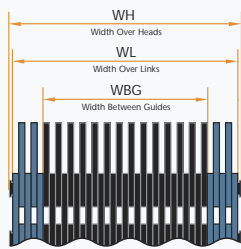

ASSEMBLY NUMBER	NOMINAL WIDTH INCHES	WL (MAX) INCHES	WBG (MIN) INCHES	SPROCKET* WIDTH INCHES	SINGLE PIN		TWO PIN	
					WH (MAX) INCHES	WEIGHT LB/FT	WH (MAX) INCHES	WEIGHT LB/FT
ML050	2	1.95	1	0.94	2.19	2.16	2.15	2.17
ML075	3	3.01	2.07	2.01	3.3	3.14	3.26	3.19
ML100	4	3.88	2.69	2.63	4.02	4.1	4.02	4.5
ML125	5	4.87	3.8	3.74	5.02	5	5.01	5.5
ML150	6	5.91	3.83	3.77	6.04	6.1	6.04	6.7
ML200	8	7.74	5.72	5.66	7.89	8.1	7.89	8.8
ML250	10	9.74	7.72	7.66	9.89	10	9.88	11
ML300	12	11.8	9.66	9.6	11.94	12.1	11.94	13.2

LINK-SPACER ASSEMBLY

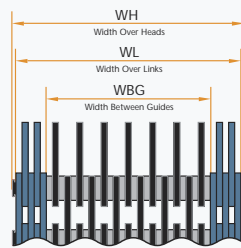

ASSEMBLY NUMBER	NOMINAL WIDTH INCHES	WL (MAX) INCHES	WBG (MIN) INCHES	SPROCKET* WIDTH INCHES	SINGLE PIN		TWO PIN	
					WH (MAX) INCHES	WEIGHT LB/FT	WH (MAX) INCHES	WEIGHT LB/FT
MS050	2	1.95	1	0.94	2.19	1.63	2.15	1.64
MS075	3	3.01	2.07	2.01	3.3	2.35	3.26	2.4
MS100	4	3.88	2.69	2.63	4.02	2.7	4.02	2.9
MS125	5	4.87	3.8	3.74	5.02	3.3	5.01	3.6
MS150	6	5.91	3.83	3.77	6.04	4	6.04	4.3
MS200	8	7.74	5.72	5.66	7.89	5.2	7.89	5.6
MS250	10	9.74	7.72	7.66	9.89	6.5	9.88	7
MS300	12	11.8	9.66	9.6	11.94	7.9	11.94	8.5

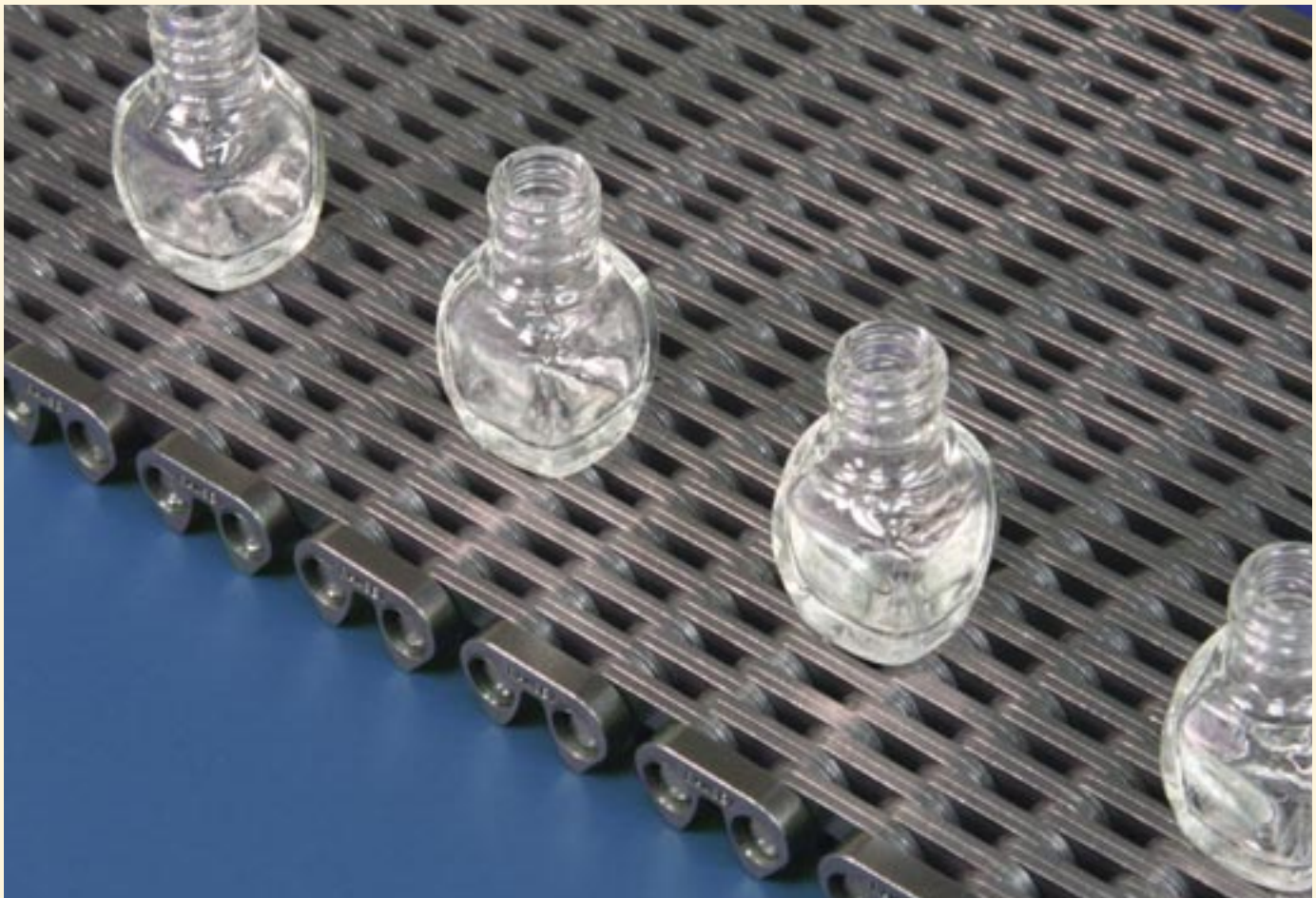

RAMSEY SPROCKETS

All Ramsey conveyor chains operate on 1/2" pitch Ramsey sprockets. Our sprockets are typically manufactured from C-1141 steel and are heat treated to provide hardened tooth surfaces.

Sprockets can be fully machined with finished bore and setscrews, or you can ask that they be supplied with an unfinished bore to allow further machining.

Specialized machining is available to accommodate a customer's exact specifications. Materials, other than steel, are available upon request.

PERFORMANCE GUIDELINES

In general, larger sprocket diameters will provide for smoother chain operation and less vibration, so it is best to avoid very small sprockets in applications that require smooth transport. In most cases, sprockets for UltraLife and Lo-Profile chains should have a minimum of 21 teeth. Sprockets for Extended Pitch Chains should have at least 26 teeth.

Sprocket Tooth profiles are cut to established standards to assure proper meshing of the sprocket and chain. Chain and sprocket dimensions must be compatible for proper operation. We recommend purchasing chain and sprockets from the same source.



SPECIFYING A SPROCKET

It is important to choose a sprocket that is compatible with your chain. You should always consider the following:

- Guide Type
- Hub Projection
- Bore Diameter
- Face Width
- Hub Diameter
- Hub Type
- Keyway Size
- Number of Teeth

For assistance in selecting a sprocket, please contact us.

GUIDE TYPE

Sprockets can be grouped into two broad categories: center guide and side/multiguide

Center Guide: A groove machined in the center of the sprocket face accepts the chain's center guide link.

Side/Multiguide: The sprocket fits between the chain's side guide plates.

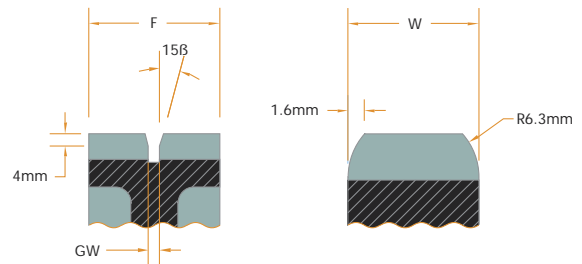

CENTER GUIDE

SIDE/MULTIGUIDE

CENTER GUIDE DATA

F = same as Nominal Chain Width

GW = Guide Width

= .1" for $F < 7.9$ ", uses a single guide link

= .2" for $F \geq 7.9$ ", uses a double guide link

SIDE/MULTIGUIDE DATA

W = WBG - 0.06" (unless otherwise specified)

WBG = Width Between Guides

(See Ordering Charts for WBG & W)

SPROCKET HUB TYPE

HUB DIMENSION DATA

- F = Nominal Chain Width
- B = Bore
- OD = Outside Diameter
- HD = Hub Diameter
- LTB = Length Through the Bore
- HP = Hub Projection

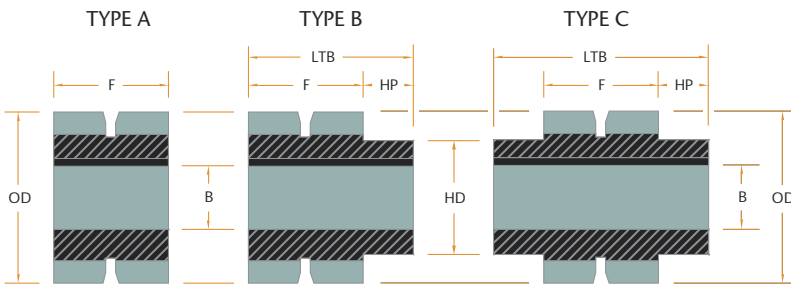

SPROCKET HUB TYPES

ADDITIONAL INFORMATION

- PD Pitch Diameter (inches) = $12.7 / \sin(180/Z)$
- GD Gross Wrapped Diameter (inches) = PD+X
- V Surface Velocity (ft/s) = $2.12 \times 10^{-4}(Z)(N)$
- N = Revolutions per Minute
- Z = Number of Teeth
- X = See chart below

X values in inches (for GD calculation)

UltraLife (1 pin)0.4
UltraLife (2 pin)0.5
Lo-Profile0.4
Extended0.4

OD=OUTSIDE DIAMETER (in inches)

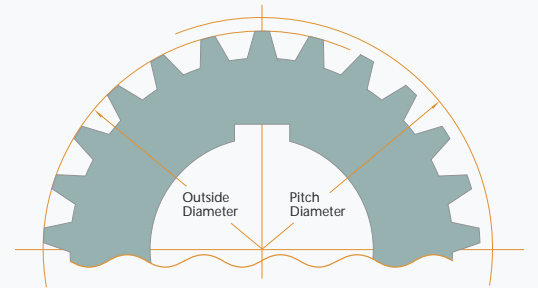

SPROCKET PROFILE

Z*	OD	Z*	OD	Z*	OD
182.8"	467.3"	7411.8"
193"	477.5"	7511.9"
203.1"	487.6"	7612.1"
213.3"	497.8"	7712.3"
223.5"	507.95"	7812.4"
233.6"	518.1"	7912.6"
243.8"	528.3"	8012.7"
253.9"	538.4"	8112.9"
264.1"	548.6"	8213.1"
274.3"	558.75"	8313.2"
284.4"	568.9"	8413.4"
294.6"	579.1"	8513.5"
304.75"	589.2"	8613.7"
314.9"	599.4"	8713.9"
325.1"	609.55"	8814"
335.2"	619.7"	8914.2"
345.4"	629.9"	9014.3"
355.55"	6310"	9114.5"
365.7"	6410.2"	9214.65"
375.9"	6510.35"	9314.8"
386.1"	6610.5"	9415"
396.2"	6710.7"	9515.1"
406.35"	6810.8"	9615.3"
416.5"	6911"	9715.45"
426.7"	7011.15"	9815.6"
436.8"	7111.3"	9915.8"
447"	7211.5"	10015.9"
457.15"	7311.6"		

*Z= Number of Teeth

INSTALLATION & USAGE GUIDELINES

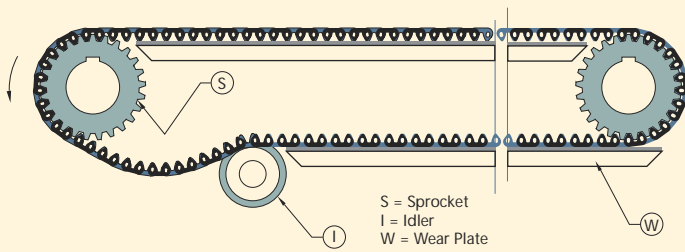

- **Wear Plates:** In most installations, the chain is supported by hardened steel wear plates under its full width. It is important that the condition of wear plates be checked periodically, since excessive wear in the plate can cause chain to wear rapidly and non-uniformly. Typically, the plate will wear more quickly in the center of the chain where weight is supported.

- **Tensioning:** When removing excess slack, take care not to over tension the chain. Excessive tension will increase chain loading, increase wear, and decrease life.
- **Guide Design:** Chain guides on the side of the conveyor have different designs depending on the equipment manufacturer. When replacing a chain it is important to choose a chain type that is compatible with the guides in use. Chain dimensions are shown on pages 10-12 for the various Ramsey chains. Sharp edges should be avoided at the entrance to each guide strip.
- **Guide Placement:** Chain guides should not restrict or interfere with the free movement of the chain.
- **Lubrication:** In most transport applications, Ramsey does not recommend routine lubrication of the chain. During shut downs, a light oil may be applied to prevent seizing. Use of lubricants can cause accumulation of debris that interferes with proper chain action and accelerates wear.
- **Chain Elongation:** As chain pitch elongates over the life of the chain, it may be necessary to remove sections of chain. This elongation is sometimes called “stretch”, even though it is caused by the wear of parts. When a chain has elongated by 3 to 4%, it is generally recommended that it be replaced.
- **Chain Link Tip Wear:** As the tips of links wear, the height of the chain is reduced. When link tips become so worn that the pin heads begin to interfere with conveyor guides, the chain should be replaced.

Ramsey Products Corporation
P.O. Box 668827
Charlotte, NC 28266-8827
Ship To: 135 Performance Drive
Belmont, NC 28012
Tel: (704) 394-0322
Fax: (704) 394-9134
www.ramseychain.com
sales@ramseychain.com



Ramsey Europe
Germany
Tel: +49 151 24042790
Great Britain
Tel: +44 (0) 7824 814116
euro.sales@ramseychain.com