

# INVERTED TOOTH Chains and Sprockets



For Power Transmission



# SILENT CHAINS FOR POWER TRANSMISSION

Ramsey Products specializes in the design, manufacture, and application of silent chain drives, also known as inverted tooth or toothed chain drives. For more than 100 years this has been our focus, and today we remain committed to providing our customers with the world's widest range of top quality silent chain products.

Because we specialize in silent chain, we understand how important it is to choose the right chain and sprockets for each application. Whether selecting components for a new application, replacing an existing chain, or custom designing a chain, our goal is to provide our customers with the most practical and cost effective solutions. If a job can be done with silent chain, we will help find the best chain for the job, at the lowest possible cost.

Many companies sell silent chain, but no one offers the product range, quality, and support provided by Ramsey. In addition to our extensive standard product line, we offer replacements for most competitors' chains, as well as custom designed chains. We also provide free consultation and drive selection assistance through our staff of experienced designers. Whether your requirement is a single chain, or a much larger volume, our sales and engineering staff has the experience to assist you. With warehouses and representatives around the world, we welcome the opportunity to serve you.

## ABOUT THIS CATALOG

Ramsey manufactures three different silent chain product lines for general power transmission. Each has unique features and advantages:

### RPV SERIES

RPV chain and sprockets are high performance products offering maximum speed and power handling capability. RPV is usually the choice for challenging applications, particularly where space is limited and power or speed requirements exceed the capacity of other products.

### RP SERIES

RP or RamPower silent chain provides approximately two times the power capacity of standard silent chain. RP chain operates on sprockets having an ASME Standard tooth profile and is well suited for new or replacement applications.

### SC SERIES

SC silent chain and sprockets are manufactured to comply with the ASME Standard for silent chain. SC products have been around the longest, are used primarily in replacement applications, and are often the most economical.



CONTENTS	SC.....11-14	Installation.....28
Silent Chain Fundamentals.....2-3	Sprockets.....15-21	Connection.....29
Applications.....4	Ordering Information.....22	Service Factors.....30
RPV.....5-7	Drive Selection.....23-25	Maintenance and Formulas.....31
RP.....8-10	Lubrication.....26-27	

## WHY SILENT CHAIN?

Silent chain offers today's drive designer unique advantages and options for transmitting power smoothly, efficiently, and economically. Capable of transmitting loads and speeds that exceed the capacity of all other chains and belts, silent chain provides proven technology that is found in applications throughout modern industry. Silent chain also produces very little vibration or noise, and operates at efficiencies as high as 99%. Add to these features a wide range of standard chain and sprocket sizes and the result is an extremely flexible and powerful system for power transmission.

### Silent Chain Drives Compared With Belts

1. Significantly higher speeds and power capacity
2. Greater efficiency
3. Larger ratios possible
4. No slippage
5. Withstands heavier overloads
6. Higher drive ratios at short center distances
7. Less affected by temperature or humidity
8. Lower bearing loads
9. Detachable and therefore more easily installed
10. Effective in oil filled gear boxes

### Silent Chain Drives Compared With Roller Chain

1. Significantly higher speeds and power capacity
2. Much quieter
3. Transmits power more smoothly, less vibration
4. Lower impact load during sprocket engagement
5. Higher efficiency (as high as 99%)
6. Longer sprocket life

### Silent Chain Drives Compared With Gears

1. Quieter than spur gears
2. Center distance much less restricted
3. Shaft parallelism tolerances are broader
4. Lower bearing loads
5. No end thrust as with helical gears
6. Greater elasticity to absorb shock

Many of the products listed in this catalog are successfully employed in applications other than power transmission. For additional information regarding other silent chain applications, such as conveying, or for details on specialty silent chain products, please call Ramsey or visit our website: [www.ramseychain.com](http://www.ramseychain.com).

## CHAIN CONSTRUCTION

Ramsey silent chains are made from hardened alloy steel components consisting of flat tooth shaped driving links, guide links and pins that form the chain joint. The driving links engage sprocket teeth much the way a rack and pinion mesh. Guide links serve to retain the chain on sprockets and pins hold the joint together and allow the chain to flex.

### DRIVING LINKS

Driving links, also known as plain links, engage sprocket teeth with less sliding and less impact than other types of chain. This results in quieter operation and longer sprocket life. Reduced impact loading also allows for higher operating speeds.



### GUIDE LINKS

Guide links maintain proper tracking of the chain on sprockets. They can be positioned on the outer edges of the chain in side guide or nearer to the middle of the chain with center guide. Wider chains will often have two rows of center guide links, commonly referred to as two center guide.



### PINS AND JOINTS

RPV, RP, and SC chains use highly specialized two-pin joints that have been developed to maximize chain load and speed capacity, while reducing friction and wear. RPV and RP use case hardened "crescent" shaped pins, while SC chains contain the original "D" shaped Ramsey pin profile, also case hardened for maximum wear resistance. The one exception is SC 3/16" pitch chain, which due to relatively light loading, is produced with a single pin joint.



RPV and RP chain joint with "crescent" shaped pins



SC chain joint with "D" shaped pins



# SILENT CHAIN FUNDAMENTALS

## HOW TWO PIN JOINTS WORK

This figure shows how the Ramsey two pin joint works. As a chain engages the sprocket, and moves from position A to position B, the convex surfaced pins roll upon one another. This rolling action eliminates the sliding friction and galling that occurs in other types of chain. Pin action also minimizes the effects of chordal action by slightly increasing chain pitch and internally moving the pitch point up to coincide with the sprockets pitch circle. As a result, the chain smoothly and efficiently engages the sprocket, very nearly tangent to the pitch circle. The smoothness and lack of vibration results in a quiet drive with higher load and speed capability.

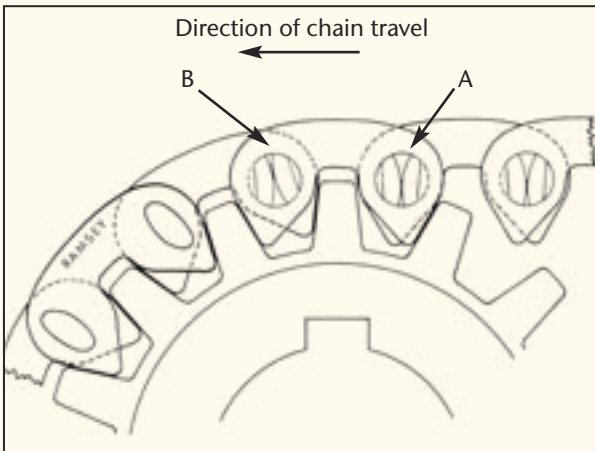

Ramsey Two Pin Joint

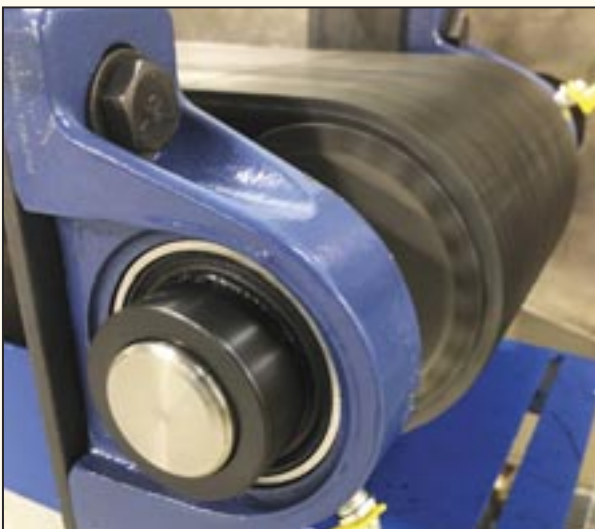

A Ramsey Silent Chain operating at high speed. Note the smoothness and lack of vibration.

## CHAIN GUIDE TYPE

Chain guide type describes the placement of guide links within the chain. The most common guide types are, one center guide, two center guide, and side guide.

### ONE CENTER GUIDE



### SIDE GUIDE



### TWO CENTER GUIDE



# APPLICATIONS



FOOD PROCESSING

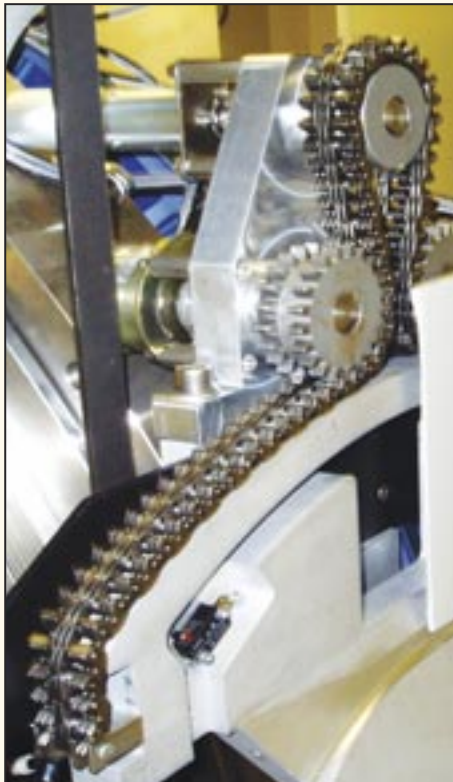

MEDICAL EQUIPMENT



SPECIALTY VEHICLES



EXTRUSION

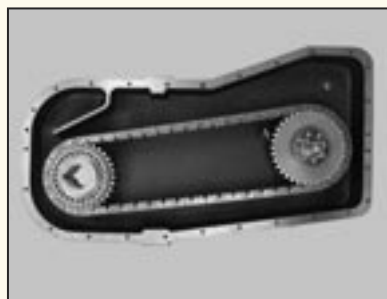

HEAVY EQUIPMENT



CONVEYING



GLASS MANUFACTURING



METAL FABRICATION

# RPV HIGH PERFORMANCE SILENT CHAIN

## RPV SERIES CHAIN

RPV is high performance inverted tooth chain, specifically designed to meet or exceed the capability of all other high performance chains. RPV is capable of speeds in excess of 7000 fpm and loads exceeding 3000 hp.

RPV's strength and load capacity comes from improved link and sprocket designs. Links are designed to minimize stress concentrations and to increase the amount of steel in the line of chain pull. Innovative stamping methods maximize the amount of load bearing surface in each link and greatly reduce the rate of chain elongation during operation. All links are shot peened to improve fatigue strength and produce a uniform, high quality finish.

RPV sprockets employ an involute tooth profile to decrease impact loading and vibration during chain engagement. RPV chain engages sprockets nearly tangent to the sprocket pitch circle, reducing the velocity variation produced by chordal action. Reduced velocity variation creates less vibration and translates directly to less wasted energy and higher load carrying capacity.

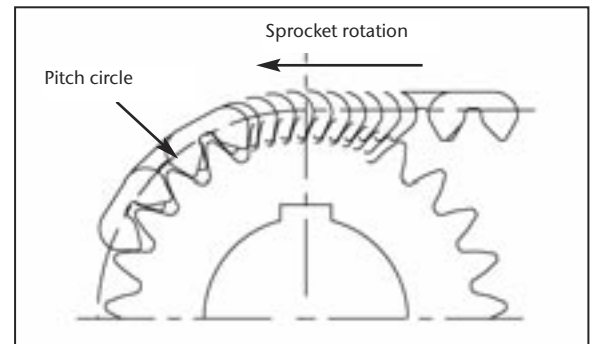
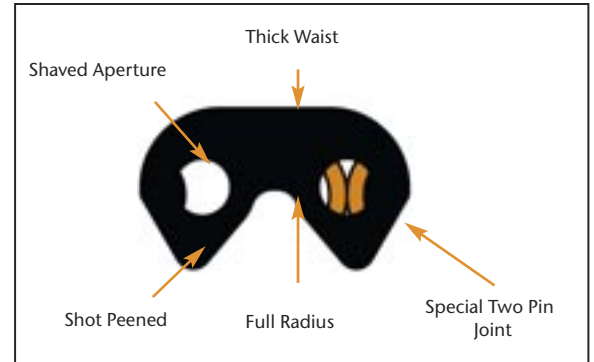

## THE RPV ADVANTAGE

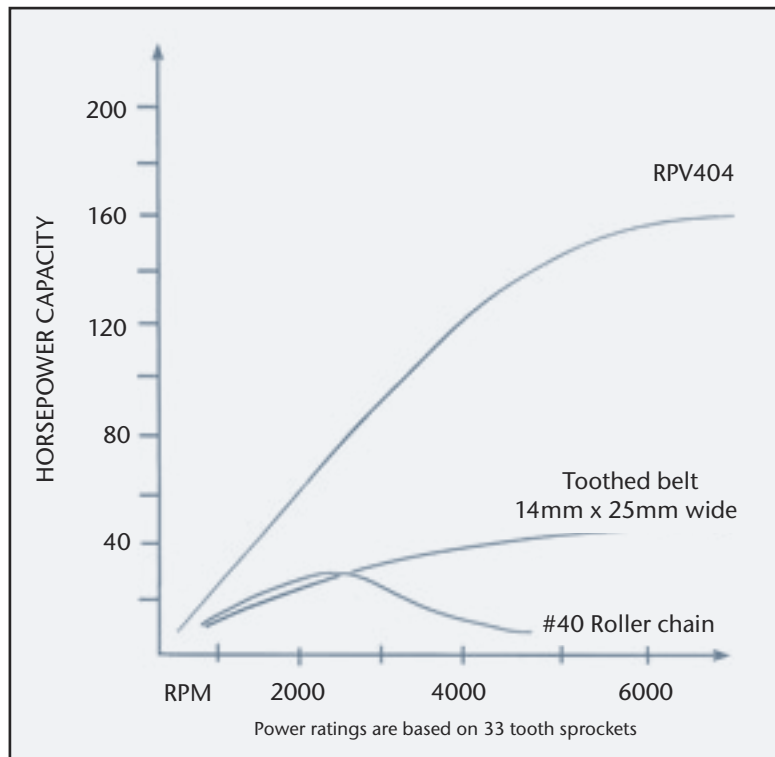



# RPV SIDE GUIDE ASSEMBLIES

## RPV SIDE GUIDE ASSEMBLIES

### 3/8" through 1" Pitch

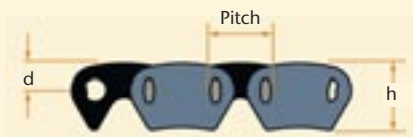

Type 139



### 1 1/2" and 2" Pitch

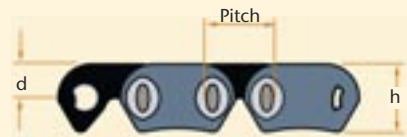

Type 115



Pitch	Part Number	Nominal Width	Width Between Guides WBG	Width Over Heads WH	Width Over Links WL	Width At Connector WC	Weight (Lbs/ft)	Breaking Load (Lbf)	h	d	t
3/8"	RPV303	3/4	0.69	0.90	0.81	1.03	0.7	6,000	0.43	0.17	0.06
	RPV304	1	0.93	1.15	1.05	1.28	0.9	8,000			
	RPV306	1 1/2	1.43	1.65	1.55	1.79	1.3	12,000			
	RPV308	2	1.93	2.16	2.05	2.29	1.8	16,000			
	RPV312	3	2.93	3.16	3.05	3.29	2.6	24,000			
1/2"	RPV404	1	0.93	1.15	1.05	1.28	1.2	11,000	0.57	0.23	0.06
	RPV406	1 1/2	1.43	1.65	1.55	1.78	1.8	16,500			
	RPV408	2	1.93	2.16	2.05	2.29	2.4	22,000			
	RPV412	3	2.93	3.16	3.05	3.29	3.5	33,000			
	RPV416	4	3.93	4.16	4.05	4.29	4.7	44,000			
3/4"	RPV606	1 1/2	1.43	1.77	1.63	1.91	3.1	24,750	0.85	0.34	0.08
	RPV608	2	1.93	2.31	2.14	2.45	3.7	33,000			
	RPV612	3	2.93	3.31	3.14	3.45	5.3	49,500			
	RPV616	4	3.93	4.31	4.14	4.45	7.0	66,000			
	RPV620	5	4.93	5.31	5.14	5.45	8.7	82,500			
1"	RPV808	2	1.89	2.40	2.23	2.51	5.0	44,000	1.14	0.45	0.12
	RPV812	3	2.89	3.40	3.23	3.51	7.2	66,000			
	RPV816	4	3.84	4.40	4.23	4.51	9.5	88,000			
	RPV820	5	4.89	5.40	5.23	5.51	11.7	110,000			
	RPV824	6	5.89	6.40	6.23	6.51	14.1	132,000			
1-1/2"	RPV1212	3	2.53	3.32	2.77	3.35	10.4	99,000	1.65	0.81	0.12
	RPV1216	4	3.53	4.32	3.77	4.35	13.8	132,000			
	RPV1220	5	4.53	5.32	4.77	5.35	17.3	165,000			
	RPV1224	6	5.53	6.32	5.77	6.35	20.7	198,000			
2"	RPV1616	4	3.37	4.40	3.69	4.42	18.4	176,000	2.19	1.08	0.16
	RPV1620	5	4.37	5.40	4.69	5.42	23.0	220,000			
	RPV1624	6	5.37	6.40	5.69	6.42	27.6	264,000			
	RPV1632	8	7.37	8.40	7.69	8.42	36.8	352,000			

Other chain widths are available  
 Unless indicated, all dimensions are in inches  
 3/4" and 1" pitch is also available in Type 115 link style

# RPV CENTER GUIDE ASSEMBLIES

## RPV CENTER GUIDE ASSEMBLIES

### 3/8" and 1/2" Pitch

Type 139

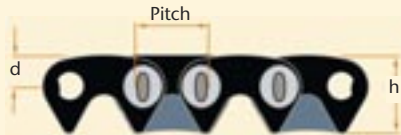

### 3/4" through 2" Pitch

Type 115

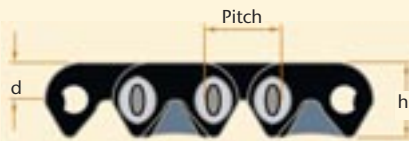

Pitch	Part Number	Nominal Width	Width Over Heads WH	Width Over Links WL	Width At Connector WC	Weight (Lbs/ft)	Breaking Load (Lbf)	h	d	t
3/8"	RPV3-025	1.0	1.28	1.07	1.33	1.0	8,000	0.43	0.17	0.06
	RPV3-030	1.2	1.52	1.32	1.58	1.2	9,600			
	RPV3-040	1.6	1.78	1.58	1.84	1.4	12,800			
	RPV3-050	2.0	2.27	2.07	2.35	1.9	16,000			
	RPV3-065	2.6	2.76	2.56	2.84	2.3	20,800			
1/2"	RPV4-325	1.0	1.30	1.09	1.40	1.3	11,000	0.57	0.23	0.06
	RPV4-330	1.2	1.54	1.34	1.63	1.6	13,200			
	RPV4-340	1.6	1.82	1.60	1.88	1.9	17,600			
	RPV4-350	2.0	2.31	2.09	2.37	2.5	22,000			
	RPV4-365	2.6	2.78	2.60	2.85	3.0	28,600			
	RPV4-375	3.0	3.33	3.12	3.40	3.6	33,000			
	RPV4-3100	3.9	4.30	4.14	4.38	4.7	42,900			
3/4"	RPV6-535	1.4	1.70	1.38	1.83	2.6	23,100	0.83	0.41	0.08
	RPV6-540	1.6	1.97	1.72	2.11	3.2	26,400			
	RPV6-550	2.0	2.31	2.03	2.44	3.7	33,000			
	RPV6-565	2.6	2.98	2.68	3.10	4.8	42,900			
	RPV6-585	3.4	3.65	3.33	3.71	6.0	56,100			
RPV6-5100	3.9	4.30	3.98	4.39	7.1	64,350				
1"	RPV8-640	1.6	2.01	1.64	2.13	4.0	35,200	1.10	0.54	0.12
	RPV8-650	2.0	2.43	2.13	2.57	5.1	44,000			
	RPV8-665	2.6	2.94	2.64	3.07	6.3	57,200			
	RPV8-675	3.0	3.45	3.13	3.57	7.4	66,000			
	RPV8-6100	3.9	4.43	4.14	4.56	9.7	85,800			
	RPV8-6125	4.9	5.44	5.14	5.57	12.0	107,800			
	RPV8-6150	5.9	6.44	6.15	6.57	14.3	129,800			

Other chain widths are available

Unless indicated, all dimensions are in inches

3/4" and 1" pitch is also available in Type 139 link style



# RP RAMPOWER SILENT CHAIN

## RP SERIES CHAIN

RP or RamPower series silent chain was designed to operate on sprockets manufactured with an ASME Standard tooth profile. Available exclusively through Ramsey, RamPower offers twice the power capacity of SC series chains and speeds up to 7,000 fpm. RamPower has been successfully employed in applications transmitting up to 2,500 hp and is often preferred where high loads and speeds must be accommodated in a small amount of space.

The increased load carrying capacity of RamPower is a result of improved link and pin designs. Working with independent laboratories, Ramsey engineers re-designed the standard SC link shape to reduce stress concentrations, improve fatigue life, and increase link tensile strength. Innovative stamping methods were also employed to maximize the amount of bearing surface area in each link. The increased bearing area produces less stress in the chain joint and greatly reduces the rate of chain elongation during operation. All chain links are shot peened to improve fatigue resistance and produce a uniform finish.

In most applications RamPower will experience very little initial elongation, making it well suited for fixed center drive applications. We recommend RamPower for all new chain drives where the customer desires to use sprockets with the ASME standard tooth profile. It is also well suited for upgrading existing SC chain applications when improved performance is desired.

RamPower is available in center guide as well as side guide assemblies.

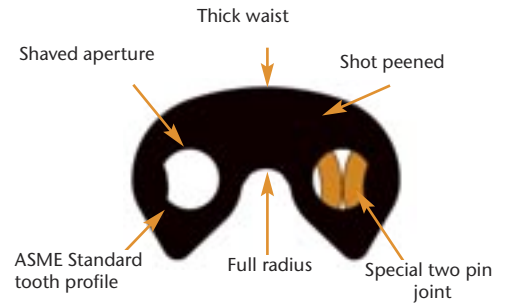

Cross section of an RP link aperture

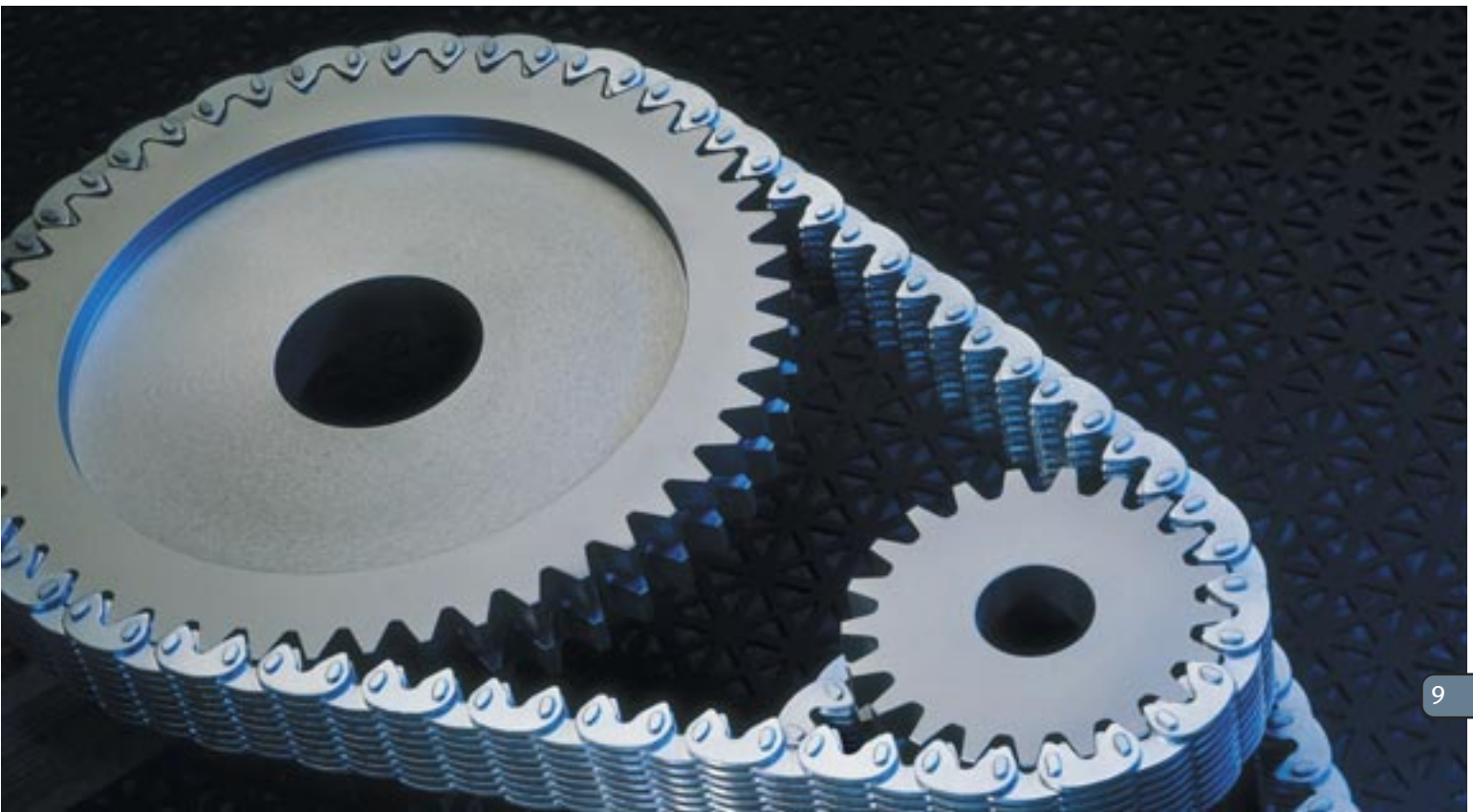
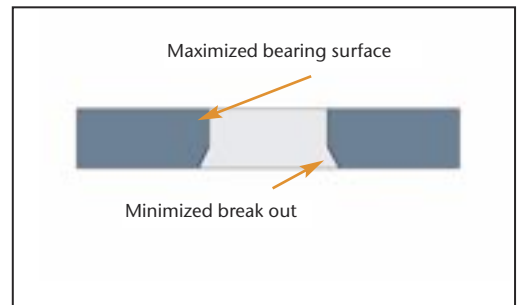

# RP CENTER GUIDE ASSEMBLIES

## RP CENTER GUIDE ASSEMBLIES

### 3/8" and 1/2" Pitch

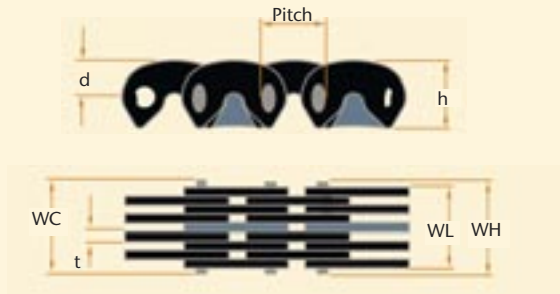

### 5/8" through 2" Pitch

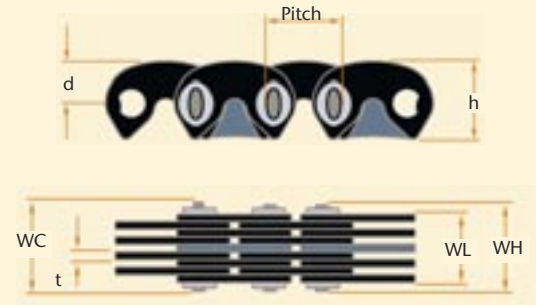

Pitch	Part Number	Nominal Width	Guide Type	Width Over Heads WH	Width Over Links WL	Width At Connector WC	Weight (Lbs/ft)	Breaking Load (Lbf)	h	d	t
3/8"	RP302	1/2	CG	0.64	0.53	0.69	0.5	3,750	0.42	0.22	0.06
	RP303	3/4	CG	0.89	0.77	0.94	0.7	5,625			
	RP304	1	CG	1.14	1.01	1.20	0.9	7,500			
	RP305	1 1/4	CG	1.39	1.25	1.45	1.1	9,375			
	RP306	1 1/2	CG	1.64	1.48	1.70	1.4	11,250			
	RP308	2	CG	2.14	1.96	2.20	1.7	15,000			
	RP310	2 1/2	CG	2.64	2.44	2.71	2.2	18,750			
	RP312	3	2CG	3.12	2.91	3.21	2.5	22,500			
RP316	4	2CG	4.12	3.86	4.22	3.4	30,000				
1/2"	RP403	3/4	CG	0.94	0.78	1.00	0.8	7,500	0.56	0.30	0.06
	RP404	1	CG	1.18	1.02	1.27	1.1	10,000			
	RP405	1 1/4	CG	1.43	1.27	1.50	1.4	12,500			
	RP406	1 1/2	CG	1.68	1.51	1.75	1.6	15,000			
	RP408	2	CG	2.18	1.99	2.25	2.2	20,000			
	RP410	2 1/2	CG	2.68	2.48	2.76	2.7	25,000			
	RP412	3	CG	3.22	2.96	3.26	3.3	30,000			
	RP414	3 1/2	CG	3.69	3.45	3.76	3.8	35,000			
	RP416	4	2CG	4.19	3.93	4.26	4.4	40,000			
	RP420	5	2CG	5.20	4.90	5.27	5.5	50,000			
RP424	6	2CG	6.16	5.86	6.25	6.5	60,000				
5/8"	RP504	1	CG	1.32	1.01	1.40	1.8	12,500	0.70	0.37	0.08
	RP506	1 1/2	CG	1.82	1.48	1.90	2.3	18,750			
	RP508	2	CG	2.30	1.95	2.38	3.0	25,000			
	RP510	2 1/2	CG	2.76	2.42	2.84	3.1	31,250			
	RP512	3	CG	3.25	2.88	3.33	4.8	37,500			
	RP514	3 1/2	CG	3.73	3.35	3.81	5.3	43,750			
	RP516	4	CG	4.22	3.82	4.30	6.0	50,000			
	RP520	5	2CG	5.18	4.75	5.26	7.6	62,500			
	RP524	6	2CG	6.18	5.69	6.26	9.0	75,000			

Other chain widths are available  
Unless indicated, all dimensions are in inches

## RP CENTER GUIDE ASSEMBLIES

Pitch	Part Number	Nominal Width	Guide Type	Width Over Heads WH	Width Over Links WL	Width At Connector WC	Weight (Lbs/ft)	Breaking Load (Lbf)	h	d	t
3/4"	RP604	1	CG	1.32	1.01	1.40	1.8	15,000	0.84	0.43	0.08
	RP606	1 1/2	CG	1.82	1.48	1.90	2.6	22,500			
	RP608	2	CG	2.30	1.95	2.38	3.5	30,000			
	RP610	2 1/2	CG	2.80	2.42	2.88	4.4	37,500			
	RP611	2 3/4	CG	2.96	2.57	3.04	4.8	41,250			
	RP612	3	CG	3.21	2.88	3.29	5.3	45,000			
	RP616	4	CG	4.21	3.82	4.29	7.0	60,000			
	RP620	5	CG	5.18	4.75	5.26	8.8	75,000			
	RP624	6	CG	6.26	5.69	6.34	10.5	90,000			
	RP628	7	2CG	7.26	6.63	7.34	12.3	105,000			
RP632	8	2CG	8.15	7.56	8.23	14.0	120,000				
1"	RP808	2	CG	2.26	1.79	2.37	4.2	40,000	1.12	0.60	0.12
	RP812	3	CG	3.19	2.73	3.35	6.3	60,000			
	RP816	4	CG	4.23	3.66	4.34	8.4	80,000			
	RP820	5	CG	5.18	4.60	5.29	10.5	100,000			
	RP824	6	CG	6.14	5.85	6.29	12.6	120,000			
	RP828	7	2CG	7.43	6.70	7.54	14.7	140,000			
	RP832	8	2CG	8.41	7.72	8.52	16.8	160,000			
	RP836	9	2CG	9.24	8.58	9.35	18.9	180,000			
	RP840	10	2CG	10.38	9.51	10.49	21.0	200,000			
RP848	12	2CG	12.44	11.54	12.56	25.2	240,000				
1-1/2"	RP1212	3	CG	3.32	2.87	3.32	9.4	90,000	1.68	0.90	0.12
	RP1216	4	CG	4.28	3.87	4.28	12.3	120,000			
	RP1220	5	CG	5.18	4.77	5.18	15.4	150,000			
	RP1224	6	CG	6.28	5.87	6.28	18.5	180,000			
	RP1228	7	CG	7.28	6.89	7.28	21.5	210,000			
	RP1232	8	2CG	8.29	7.90	8.29	24.6	240,000			
	RP1236	9	2CG	9.32	8.92	9.32	26.3	270,000			
	RP1240	10	2CG	10.42	10.00	10.42	30.8	300,000			
2"	RP1616	4	CG	4.34	3.67	4.34	16.4	160,000	2.25	1.20	0.12
	RP1620	5	CG	5.34	4.62	5.34	20.5	200,000			
	RP1624	6	CG	6.34	5.56	6.34	24.6	240,000			
	RP1628	7	CG	7.34	6.51	7.34	28.7	280,000			
	RP1632	8	2CG	8.34	7.46	8.34	32.8	320,000			
	RP1640	10	2CG	10.34	9.36	10.34	41.0	400,000			
	RP1648	12	2CG	12.34	11.25	12.34	49.2	480,000			
	RP1656	14	2CG	14.59	13.39	14.59	57.4	560,000			
RP1664	16	2CG	16.59	15.04	16.59	65.6	640,000				

Other chain widths are available  
 Unless indicated, all dimensions are in inches

# SC INDUSTRY STANDARD SILENT CHAIN

## SC SERIES

SC series chain is available in center guide and side guide assemblies. Center guide assemblies are fully compliant with the ASME Standard for silent chain. Both side guide and center guide operate on industry standard sprockets.

SC chain can accommodate speeds approaching 6500 fpm and loads in excess of 1000 hp. Utilizing the patented Ramsey roller bearing joint, SC chain is Ramsey's most popular industrial chain.

We recommend SC chain primarily as a replacement chain for existing power transmission applications where it has been successfully employed in the past. SC chain weighs less than an equal width of RPV or RP chain, and it typically costs less.

## SC CENTER GUIDE ASSEMBLIES

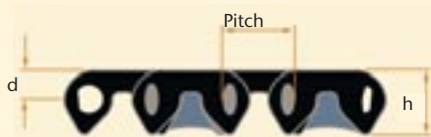

One Center Guide



Two Center Guide



Pitch	Part Number	Nominal Width	Guide Type	Width Over Heads WH	Width Over Links WL	Width At Connector WC	Weight (lbs/ft)	Breaking Load (lbf)	h	d	t
3/8"	SC302	1/2	SG	0.52	0.41	0.57	0.4	1,970	0.37	0.18	0.06
	SC303	3/4	CG	0.77	0.65	0.82	0.5	2,950			
	SC304	1	CG	1.02	0.89	1.08	0.7	3,940			
	SC305	1 1/4	CG	1.27	1.13	1.33	0.9	4,920			
	SC306	1 1/2	CG	1.52	1.36	1.58	1.1	5,910			
	SC308	2	CG	2.02	1.84	2.08	1.4	7,880			
	SC310	2 1/2	CG	2.52	2.32	2.59	1.8	9,840			
	SC312	3	2CG	3.00	2.79	3.09	2.1	11,810			
SC316	4	2CG	4.00	3.74	4.10	2.8	15,750				
1/2"	SC402	1/2	SG	0.55	0.42	0.63	0.5	2,620	0.47	0.21	0.06
	SC403	3/4	CG	0.81	0.66	0.88	0.7	3,940			
	SC404	1	CG	1.06	0.9	1.13	0.9	5,250			
	SC405	1 1/4	CG	1.31	1.14	1.38	1.1	6,560			
	SC406	1 1/2	CG	1.56	1.39	1.63	1.4	7,870			
	SC408	2	CG	2.06	1.87	2.13	1.8	10,500			
	SC410	2 1/2	CG	2.56	2.35	2.63	2.3	13,120			
	SC412	3	CG	3.07	2.84	3.14	2.7	15,750			
	SC414	3 1/2	CG	3.57	3.32	3.64	3.2	18,370			
	SC416	4	2CG	4.07	3.81	4.14	3.6	21,000			
	SC420	5	2CG	5.08	4.77	5.15	4.5	26,250			
	SC424	6	2CG	6.09	5.74	6.16	5.4	31,500			
SC428	7	2CG	7.09	6.71	7.16	6.3	36,750				

Other chain widths are available  
Unless indicated, all dimensions are in inches



## SC CENTER GUIDE ASSEMBLIES

Pitch	Part Number	Nominal Width	Guide Type	Width Over Heads WH	Width Over Links WL	Width At Connector WC	Weight (lbs/ft)	Breaking Load (lbf)	h	d	t
5/8"	SC504	1	CG	1.21	1.01	1.28	1.2	6,250	0.65	0.33	0.08
	SC506	1 1/2	CG	1.54	1.33	1.61	1.8	9,370			
	SC508	2	CG	2.03	1.79	2.10	2.4	12,500			
	SC510	2 1/2	CG	2.53	2.26	2.60	3.0	15,620			
	SC512	3	CG	3.02	2.73	3.09	3.6	18,750			
	SC516	4	CG	4.01	3.67	4.08	4.8	25,000			
	SC520	5	2CG	5.00	4.60	5.07	6.0	31,250			
	SC524	6	2CG	5.99	5.54	6.06	7.2	37,500			
SC532	8	2CG	8.14	7.56	8.21	9.6	50,000				
3/4"	SC604	1	CG	1.22	1.01	1.35	1.5	7,870	0.80	0.41	0.08
	SC606	1 1/2	CG	1.57	1.33	1.68	2.3	11,810			
	SC608	2	CG	2.05	1.79	2.18	3.0	15,750			
	SC610	2 1/2	CG	2.54	2.26	2.67	3.8	19,690			
	SC612	3	CG	3.04	2.73	3.17	4.5	23,620			
	SC616	4	CG	4.03	3.66	4.16	6.0	31,500			
	SC620	5	CG	5.02	4.60	5.15	7.5	39,370			
	SC624	6	CG	6.01	5.54	6.14	9.0	47,250			
	SC628	7	2CG	7.16	6.63	7.29	10.5	55,120			
SC632	8	2CG	8.15	7.56	8.28	12.0	63,000				
1"	SC808	2	CG	2.06	1.78	2.17	3.6	21,000	0.98	0.48	0.12
	SC812	3	CG	3.05	2.72	3.17	5.4	31,500			
	SC816	4	CG	4.04	3.67	4.16	7.2	42,000			
	SC820	5	CG	5.03	4.62	5.15	9.0	52,500			
	SC824	6	CG	6.05	5.56	6.16	10.8	63,000			
	SC828	7	2CG	7.04	6.51	7.16	12.6	73,500			
	SC832	8	2CG	8.04	7.46	8.16	14.4	84,000			
	SC836	9	2CG	9.03	8.41	9.15	16.2	94,500			
	SC840	10	2CG	10.03	9.36	10.15	18.0	105,000			
SC848	12	2CG	12.02	11.25	12.14	21.6	126,000				
1-1/2"	SC1212	3	CG	3.34	2.72	3.34	9	47,250	1.50	0.71	0.12
	SC1216	4	CG	4.34	3.67	4.34	12	63,000			
	SC1220	5	CG	5.34	4.62	5.34	15	78,750			
	SC1224	6	CG	6.34	5.56	6.34	18	94,500			
	SC1228	7	CG	7.34	6.51	7.34	21	110,250			
	SC1232	8	2CG	8.34	7.46	8.34	24	126,000			
	SC1236	9	2CG	9.34	8.41	9.34	27	141,750			
	SC1240	10	2CG	10.34	9.36	10.34	30	157,500			
	SC1248	12	2CG	12.34	11.25	12.34	36	189,000			
	SC1256	14	2CG	14.59	13.39	14.59	42	220,500			
SC1264	16	2CG	16.59	15.28	15.28	48	252,000				

Other chain widths are available  
 Unless indicated, all dimensions are in inches

# SC SIDE GUIDE

## SC SIDE GUIDE ASSEMBLIES

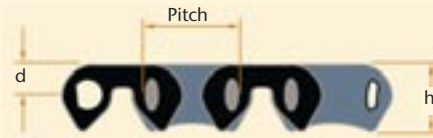

Pitch	Part Number	Nominal Width	Width Between Guides WBG	Width Over Heads WH	Width Over Links WL	Width At Connector WC	Weight (lbs/ft)	Breaking Load (lbf)	h	d	t
3/8"	DSG302	1/2	1/4	0.58	0.48	0.63	0.4	1,970	0.37	0.18	0.06
	DSG303	3/4	1/2	0.84	0.71	0.89	0.6	2,950			
	DSG304	1	3/4	1.09	0.95	1.15	0.8	3,940			
	DSG305	1 1/4	1	1.34	1.19	1.40	0.9	4,920			
	DSG306	1 1/2	1 1/4	1.59	1.43	1.65	1.1	5,910			
	DSG308	2	1 3/4	2.09	1.90	2.15	1.7	7,880			
	DSG310	2 1/2	2 1/4	2.58	2.38	2.65	1.9	9,840			
	DSG312	3	2 3/4	3.09	2.86	3.16	2.2	11,810			
	DSG316	4	3 3/4	4.10	3.81	4.16	3.3	15,750			
1/2"	DSG402	1/2	1/4	0.62	0.48	0.68	0.5	2,620	0.47	0.21	0.06
	DSG403	3/4	1/2	0.87	0.73	0.94	0.8	3,940			
	DSG404	1	3/4	1.12	0.97	1.19	1.0	5,250			
	DSG405	1 1/4	1	1.38	1.21	1.45	1.2	6,560			
	DSG406	1 1/2	1 1/4	1.63	1.45	1.70	1.5	7,870			
	DSG408	2	1 3/4	2.12	1.94	2.19	2.0	10,500			
	DSG410	2 1/2	2 1/4	2.63	2.42	2.69	2.5	13,120			
	DSG412	3	2 3/4	3.13	2.90	3.20	2.9	15,750			
	DSG416	4	3 3/4	4.14	3.63	4.21	3.9	21,000			
5/8"	DSG504	1	3/4	1.21	1.01	1.28	1.2	6,560	0.65	0.33	0.08
	DSG506	1 1/2	1 1/4	1.70	1.48	1.77	1.8	9,840			
	DSG508	2	1 3/4	2.28	2.03	2.35	2.5	13,130			
	DSG510	2 1/2	2 1/4	2.77	2.50	2.84	3.1	16,410			
	DSG512	3	2 3/4	3.27	2.96	3.34	3.7	19,690			
	DSG514	3 1/2	3 1/4	3.76	3.43	3.83	4.3	22,970			
	DSG516	4	3 3/4	4.34	3.98	4.41	4.9	26,250			
	DSG520	5	4 3/4	5.33	4.91	5.40	6.1	32,810			
3/4"	DSG606	1 1/2	1	1.55	1.33	1.68	2.2	11,810	0.80	0.41	0.08
	DSG608	2	1 1/2	2.05	1.79	2.18	2.9	15,750			
	DSG610	2 1/2	2	2.54	2.26	2.67	3.7	19,690			
	DSG612	3	2 1/2	3.04	2.73	3.17	4.4	23,620			
	DSG614	3 1/2	3	3.53	3.20	3.66	5.1	27,560			
	DSG616	4	3 1/2	4.03	3.67	4.16	5.9	31,500			
	DSG620	5	4 1/2	5.02	4.60	5.15	7.4	39,370			
	DSG624	6	5 1/2	6.01	5.54	6.14	8.8	47,250			
	DSG628	7	6 1/2	7.16	6.63	7.29	10.3	55,120			

## SC SIDE GUIDE ASSEMBLIES

Pitch Number	Part Width	Nominal WBG	Width Between Guides WH	Width Over Heads WL	Width Over Links WC	Width At Connector (lbs/ft)	Weight (lbf)	Breaking Load	h	d	t
1"	DSG808	2	1 1/2	2.18	1.90	2.30	3.9	21,000	0.98	0.48	0.12
	DSG810	2 1/2	2	2.68	2.37	2.79	4.8	26,250			
	DSG812	3	2 1/2	3.17	2.84	3.29	5.9	31,500			
	DSG816	4	3 1/2	4.29	3.91	4.41	7.8	42,000			
	DSG820	5	4 1/2	5.28	4.86	5.40	9.8	52,500			
	DSG824	6	5 1/2	6.30	5.81	6.41	11.7	63,000			
	DSG828	7	6 1/2	7.42	6.87	7.53	13.7	73,500			
	DSG832	8	7 1/2	8.41	7.82	8.53	15.7	84,000			

## SC 3/16" PITCH CHAIN

Ramsey 3/16" pitch chain is manufactured to ASME standards and will operate on standard sprockets. Chains are made entirely of 304 stainless steel and are available in side guide or center guide assemblies, depending on chain width.

## SC 3/16" PITCH CHAIN

### CENTER GUIDE

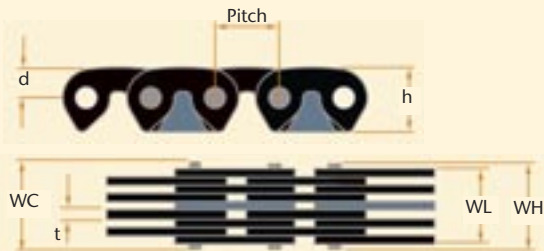

### SIDE GUIDE

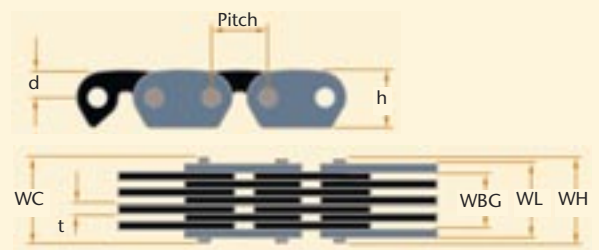

Pitch	Part Number	Nominal Width	Guide Type	Width Between Guides WBG	Width Over Heads WH	Width Over Links WL	Width At Connector WC	Weight (oz/ft)	h	d	t
3/16"	SC0305	5/32	SG	3/32	0.22	0.16	0.22	1.2	0.20	0.10	0.03
	SC0307	7/32	SG	5/32	0.27	0.22	0.27	1.6			
	SC0309	9/32	SG	7/32	0.34	0.28	0.34	1.9			
	SC0311	11/32	SG	9/32	0.40	0.35	0.40	2.4			
	SC0315	15/32	SG	13/32	0.53	0.48	0.53	3.2			
	SC0315A	15/32	CG		0.53	0.48	0.53	3.2			
	SC0319	19/32	CG		0.65	0.61	0.65	4.3			
	SC0319A	19/32	SG	17/32	0.65	0.61	0.65	4.3			
	SC0325	25/32	CG		0.86	0.81	0.86	5.4			
	SC0325A	25/32	SG	23/32	0.86	0.81	0.86	5.4			
	SC0331	31/32	CG		1.03	0.98	1.03	6.7			

# SPROCKETS

Ramsey offers a full range of stock and made to order sprockets. Because they are produced in larger quantities, stock sprockets are often the most economical choice. Made to order sprockets provide a wider range of drive ratio options and are a large part of our daily production.

All sprockets can be fully machined to your specifications or you can request they be supplied with an unfinished bore to allow secondary machining. Ramsey also supplies sprockets to replace most competitors' products. We welcome all inquiries.

## MATERIALS

RPV, RP and SC sprockets are typically made from carbon steel or ductile iron, with sprocket teeth hardened to Rockwell hardness of Rc 50. For RP and SC only, some sprocket sizes are available in class 30 gray iron with unhardened teeth. Other materials are available subject to customer preference, sprocket size, cost, and availability.

## PERFORMANCE GUIDELINES

In general, larger sprocket diameters will provide for smoother operation, less vibration, and longer life. We recommend using sprockets with at least 21 teeth whenever possible. Also, to assure proper meshing of sprockets and chain we recommend they be purchased from the same source.

## GUIDE TYPE

Similar to chains, sprockets can be grouped into two broad categories: center guide and side guide.

**Center Guide** A groove machined in the center of the sprocket face accepts the chain's center guide link. Two grooves are machined for two center guide.

**Side Guide** The sprocket fits between the chain's side guide plates.

## SPROCKET FACE PROFILES

One Center Guide

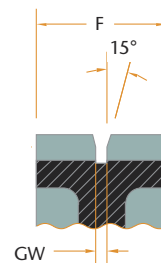

Two Center Guide

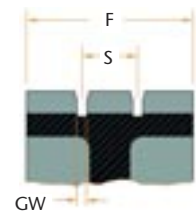

F = Face Width, the same as the nominal chain width

### CENTER GUIDE GROOVE WIDTH AND GUIDE SPACING

Pitch	3/16"	3/8"	1/2"	5/8"	3/4"	1"	1-1/2"	2"
GW	0.050	0.125	0.125	0.156	0.156	0.250	0.250	0.250
S*		1.0	1.0	2.0	4.0	4.0	4.0	4.0

Table values in inches

\*Only applies to sprockets for two center guide chains

## Side Guide

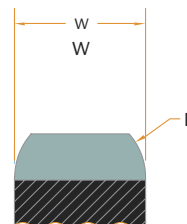

$$W_{\max} = WBG - X$$

WBG = Chain width between guides  
(See Chain data tables)

### SPROCKET WIDTH AND CHAMFER DATA FOR RP AND SC SPROCKETS

Pitch	3/16"	3/8"	1/2"	5/8"	3/4"	1"	1-1/2"
X	0.020	0.060	0.060	0.060	0.060	0.125	0.125
R	0.030	0.190	0.250	0.310	0.375	0.500	0.750

Table values in inches

Consult Ramsey for RPV Sprocket Dimensions



## HUB TYPES

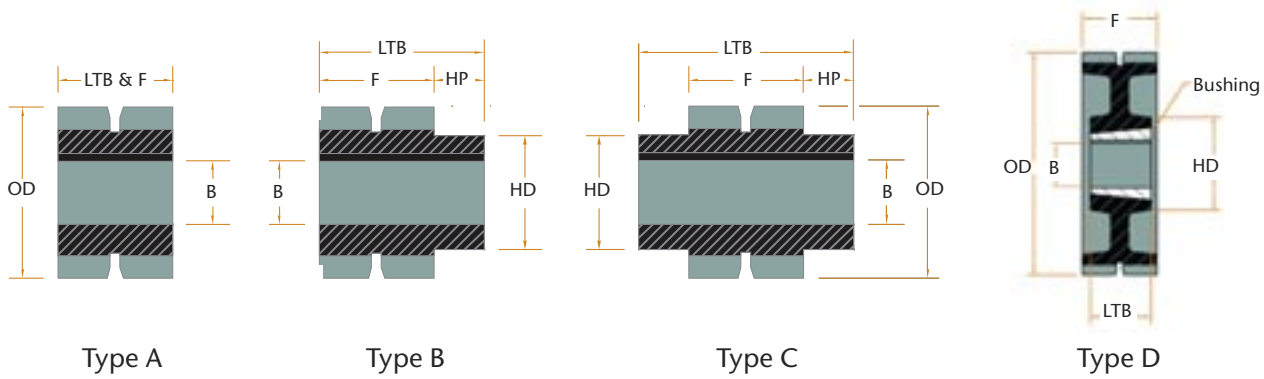

F = Nominal Chain Width  
 B = Bore  
 OD = Outside Diameter  
 HD = Hub Diameter  
 LTB = Length Through the Bore  
 HP = Hub Projection

## RPV STANDARD SPROCKETS

### 3/8" PITCH

3/4" Nominal Face Width-Type B Hub		Actual Face Width = 0.66"						
Number of Teeth	Part Number	Pitch Diameter	Outside Diameter	Minimum Plain Bore	Maximum Bore	Hub Diameter	Length Thru Bore	Approximate Weight (lb)
19	RPV303-19	2.278	2.138	0.50	1.16	1.63	1.41	0.9
21	RPV303-21	2.516	2.381	0.50	1.28	1.88	1.41	1.2
23	RPV303-23	2.754	2.624	0.50	1.38	2.13	1.41	1.5
25	RPV303-25	2.992	2.866	0.75	1.63	2.38	1.41	1.8
27	RPV303-27	3.230	3.111	0.75	1.75	2.63	1.41	2.2
29	RPV303-29	3.468	3.353	0.75	1.81	2.81	1.41	2.6
31	RPV303-31	3.707	3.594	0.75	2.13	3.06	1.41	3.1
38	RPV303-38	4.541	4.435	0.75	2.88	3.94	1.41	5.0
42	RPV303-42	5.018	4.915	0.75	3.31	4.41	1.41	6.3
57	RPV303-57	6.807	6.712	1.25	4.50	6.00	1.41	11.7
76	RPV303-76	9.074	8.984	1.25	4.50	6.00	1.41	16.7

1" Nominal Face Width-Type B Hub		Actual Face Width = 0.90"						
Number of Teeth	Part Number	Pitch Diameter	Outside Diameter	Minimum Plain Bore	Maximum Bore	Hub Diameter	Length Thru Bore	Approximate Weight (lb)
19	RPV304-19	2.278	2.138	0.50	1.16	1.63	1.63	1.1
21	RPV304-21	2.516	2.381	0.50	1.28	1.88	1.63	1.4
23	RPV304-23	2.754	2.624	0.50	1.38	2.13	1.63	1.8
25	RPV304-25	2.992	2.866	0.75	1.63	2.38	1.63	2.1
27	RPV304-27	3.230	3.111	0.75	1.75	2.63	1.63	2.6
29	RPV304-29	3.468	3.353	0.75	1.81	2.81	1.63	3.1
31	RPV304-31	3.707	3.594	0.75	2.13	3.06	1.63	3.6
38	RPV304-38	4.541	4.435	0.75	2.88	3.94	1.63	5.8
42	RPV304-42	5.018	4.915	0.75	3.31	4.41	1.63	7.4
57	RPV304-57	6.807	6.712	1.25	4.50	6.00	1.63	13.7
76	RPV304-76	9.074	8.984	1.25	4.50	6.00	1.63	20.6

Unless indicated, all dimensions in inches

# RPV STANDARD SPROCKETS

## 3/8" PITCH

1 1/2" Nominal Face Width-Type B Hub			Actual Face Width = 1.40"					
Number of Teeth	Part Number	Pitch Diameter	Outside Diameter	Minimum Plain Bore	Maximum Bore	Hub Diameter	Length Thru Bore	Approximate Weight (lb)
19	RPV306-19	2.278	2.138	0.50	1.16	1.63	2.16	1.5
21	RPV306-21	2.516	2.381	0.50	1.28	1.88	2.16	1.9
23	RPV306-23	2.754	2.624	0.50	1.38	2.13	2.16	2.4
25	RPV306-25	2.992	2.866	0.75	1.63	2.38	2.16	2.8
27	RPV306-27	3.230	3.111	0.75	1.75	2.63	2.16	3.4
29	RPV306-29	3.468	3.353	0.75	1.81	2.81	2.16	4.1
31	RPV306-31	3.707	3.594	0.75	2.13	3.06	2.16	4.8
38	RPV306-38	4.541	4.435	0.75	2.88	3.94	2.16	7.8
42	RPV306-42	5.018	4.915	0.75	3.31	4.41	2.16	9.7
57	RPV306-57	6.807	6.712	1.25	4.50	6.00	2.16	18.2
76	RPV306-76	9.074	8.984	1.25	4.50	6.00	2.16	28.9

## 1/2" PITCH

1" Nominal Face Width-Type B Hub			Actual Face Width = 0.90"					
Number of Teeth	Part Number	Pitch Diameter	Outside Diameter	Minimum Plain Bore	Maximum Bore	Hub Diameter	Length Thru Bore	Approximate Weight (lb)
19	RPV404-19	3.038	2.851	0.50	1.44	2.22	2.00	2.5
21	RPV404-21	3.355	3.175	0.50	1.69	2.50	2.00	3.3
23	RPV404-23	3.672	3.498	0.75	1.81	2.88	2.00	4.0
25	RPV404-25	3.989	3.821	0.75	2.13	3.19	2.00	4.9
27	RPV404-27	4.307	4.149	0.75	2.38	3.50	2.00	5.9
29	RPV404-29	4.625	4.47	0.75	2.56	3.81	2.00	7.0
31	RPV404-31	4.942	4.792	0.75	2.75	4.16	2.50	10.1
38	RPV404-38	6.055	5.913	0.75	3.75	5.28	2.50	16.1
42	RPV404-42	6.691	6.553	0.75	4.38	5.94	2.50	20.2
57	RPV404-57	9.076	8.949	1.25	4.50	6.00	2.50	27.1
76	RPV404-76	12.099	11.978	1.00	2.50	3.63	2.00	31.1

Unless indicated, all dimensions in inches

## 1/2" PITCH

1 1/2" Nominal Face Width-Type B Hub		Actual Face Width = 1.40"						
Number of Teeth	Part Number	Pitch Diameter	Outside Diameter	Minimum Plain Bore	Maximum Bore	Hub Diameter	Length Thru Bore	Approximate Weight (lb)
19	RPV406-19	3.038	2.851	0.50	1.44	2.22	2.50	3.3
21	RPV406-21	3.355	3.175	0.50	1.69	2.50	2.50	4.3
23	RPV406-23	3.672	3.498	0.75	1.81	2.88	2.50	5.1
25	RPV406-25	3.989	3.821	0.75	2.13	3.19	2.50	6.3
27	RPV406-27	4.307	4.149	0.75	2.38	3.50	2.50	7.6
29	RPV406-29	4.625	4.47	0.75	2.56	3.81	2.50	9.0
31	RPV406-31	4.942	4.792	0.75	2.75	4.16	3.00	12.3
38	RPV406-38	6.055	5.913	0.75	3.75	5.28	3.00	19.7
42	RPV406-42	6.691	6.553	0.75	4.38	5.94	3.00	24.6
57	RPV406-57	9.076	8.949	1.25	4.50	6.00	3.00	35.4
76	RPV406-76	12.099	11.978	1.00	2.50	3.63	2.50	46.1
2" Nominal Face Width-Type B Hub		Actual Face Width = 1.90"						
19	RPV408-19	3.038	2.851	0.50	1.44	2.22	3.00	4.1
21	RPV408-21	3.355	3.175	0.50	1.69	2.50	3.00	5.2
23	RPV408-23	3.672	3.498	0.75	1.81	2.88	3.00	6.3
25	RPV408-25	3.989	3.821	0.75	2.13	3.19	3.00	7.7
27	RPV408-27	4.307	4.149	0.75	2.38	3.50	3.00	9.2
29	RPV408-29	4.625	4.47	0.75	2.56	3.81	3.00	10.9
31	RPV408-31	4.942	4.792	0.75	2.75	4.16	3.00	12.7
38	RPV408-38	6.055	5.913	0.75	3.75	5.28	3.00	20.1
42	RPV408-42	6.691	6.553	0.75	4.38	5.94	3.00	25.1
57	RPV408-57	9.076	8.949	1.25	4.50	6.00	3.50	43.6
76	RPV408-76	12.099	11.978	1.00	2.50	3.63	3.00	60.7
3" Nominal Face Width-Type B Hub		Actual Face Width = 2.90"						
19	RPV412-19	3.038	2.851	0.50	1.44	2.22	4.00	5.3
21	RPV412-21	3.355	3.175	0.50	1.69	2.50	4.00	6.9
23	RPV412-23	3.672	3.498	0.75	1.81	2.88	4.00	8.6
25	RPV412-25	3.989	3.821	0.75	2.13	3.19	4.00	10.5
27	RPV412-27	4.307	4.149	0.75	2.38	3.50	4.00	12.6
29	RPV412-29	4.625	4.47	0.75	2.56	3.81	4.00	14.7
31	RPV412-31	4.942	4.792	0.75	2.75	4.16	4.00	17.3
38	RPV412-38	6.055	5.913	0.75	3.75	5.28	4.00	27.2
42	RPV412-42	6.691	6.553	0.75	4.38	5.94	4.00	33.9
57	RPV412-57	9.076	8.949	1.25	4.50	6.00	4.50	60.2
76	RPV412-76	12.099	11.978	1.00	2.50	3.63	4.00	83.2

Unless indicated, all dimensions in inches

# RP AND SC STANDARD SPROCKETS

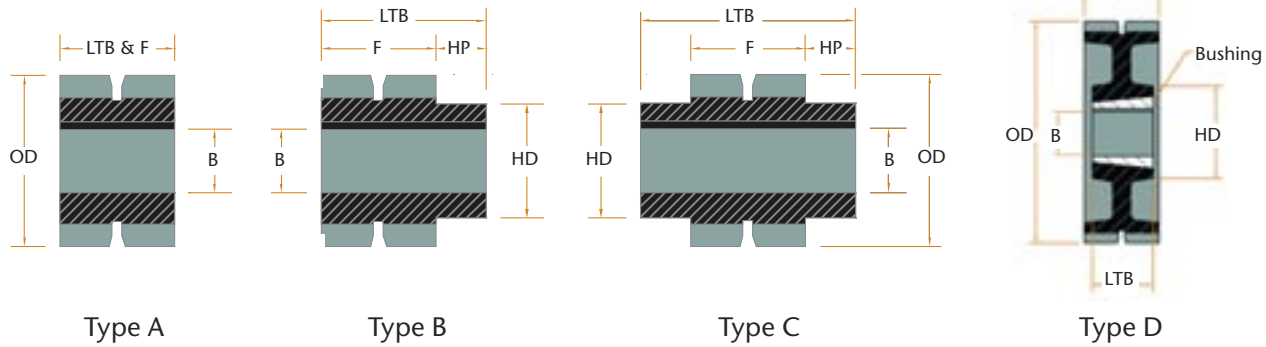

F = Nominal Chain Width  
 B = Bore  
 OD = Outside Diameter  
 HD = Hub Diameter  
 LTB = Length Through the Bore  
 HP = Hub Projection

## 3/8" PITCH

### 1" Nominal Face Width

Number of Teeth	Part Number	Pitch Diameter	Outside Diameter	Hub Type	Minimum Plain Bore	Maximum Bore	Hub Diameter	Length Thru Bore	Approx Weight(lb)	Material
17	SC304-17	2.041	1.987	B	0.50	0.88	1.44	1.75	0.9	Steel
19	SC304-19	2.278	2.23	B	0.50	1.25	1.63	1.75	1.2	Steel
21	SC304-21	2.516	2.473	B	0.50	1.31	1.88	1.75	1.6	Steel
23	SC304-23	2.935	2.716	B	0.50	1.50	2.13	1.75	2.0	Steel
25	SC304-25	2.992	2.959	B	0.50	1.75	2.38	1.75	2.5	Steel

## 1/2" PITCH

### 1" Nominal Face Width

Number of Teeth	Part Number	Pitch Diameter	Outside Diameter	Hub Type	Minimum Plain Bore	Maximum Bore	Hub Diameter	Length Thru Bore	Approx Weight(lb)	Material
17	404-17	2.721	2.649	B	0.75	1.38	1.88	1.75	1.5	Steel
19	404-19	3.038	2.973	B	0.75	1.63	2.25	1.75	2.0	Steel
21	404-21	3.355	3.297	B	0.75	1.88	2.56	1.75	2.8	Steel
23	404-23	3.672	3.621	B	0.75	2.13	2.88	1.75	3.5	Steel
25	404-25	3.989	3.945	B	0.75	2.38	3.19	1.75	4.5	Steel
38	404-38	6.055	6.038	B	1.00	2.50	4.00	1.75	8.0	Steel
38	404-38 TLB	6.055	6.038	B	1615 TLB		4.00	1.50	6.0	Steel
57	404-57	9.076	9.077	C	1.00	2.50	4.00	2.00	19.0	Steel
57	404-57 TLB	9.076	9.077	D	1615 TLB		4.00	1.50	16.0	Steel
76	404-76	12.099	12.108	C	1.00	2.50	4.00	1.50	29.5	Cast Iron
76	404-76 TLB	12.099	12.108	D	1615 TLB		4.00	2.00	32.0	Steel
95	404-95	15.122	15.135	C	1.13	3.00	5.00	2.00	52.5	Cast Iron
95	404-95 TLB	15.122	15.135	D	2517 TLB		5.00	1.75	40.0	Cast Iron
114	404-114	18.146	18.162	C	1.13	3.00	5.00	2.00	33.0	Cast Iron
114	404-114 TLB	18.146	18.162	D	2517 TLB		5.00	1.75	28.5	Cast Iron

Unless indicated, all dimensions in inches



## 1/2" PITCH

### 2" Nominal Face Width

Number of Teeth	Part Number	Pitch Diameter	Outside Diameter	Hub Type	Minimum Plain Bore	Maximum Bore	Hub Diameter	Length Thru Bore	Approx Weight(lb)	Material
17	408-17	2.721	2.649	B	0.88	1.38	1.88	2.75	2.5	Steel
19	408-19	3.038	2.973	B	0.88	1.63	2.25	2.75	3.5	Steel
21	408-21	3.355	3.297	B	0.88	1.88	2.56	2.75	4.5	Steel
23	408-23	3.672	3.621	B	0.88	2.13	2.88	2.75	5.5	Steel
25	408-25	3.989	3.945	B	0.88	2.38	3.19	2.75	7.0	Steel
38	408-38	6.055	6.038	B	1.00	2.50	4.00	2.75	16.0	Steel
38	408-38 TLB	6.055	6.038	D	1615 TLB			1.50	9.0	Steel
57	408-57	9.076	9.077	C	1.00	2.50	5.00	3.00	38.0	Steel
57	408-57 TLB	9.076	9.077	D	2517 TLB			1.75	25.0	Steel
76	408-76	12.099	12.108	C	1.25	2.50	5.00	3.00	41.0	Cast Iron
76	408-76 TLB	12.099	12.108	D	2517 TLB		5.75	2.50	36.0	Cast Iron
95	408-95	15.122	15.135	C	1.25	3.00	5.00	3.00	41.5	Cast Iron
95	408-95 TLB	15.122	15.135	D	2525 TLB		5.00	2.50	36.0	Cast Iron
114	408-114	18.146	18.162	C	1.25	3.00	5.00	3.00	47.0	Cast Iron
114	408-114 TLB	18.146	18.162	D	2525 TLB		5.00	2.50	40.0	Cast Iron

### 3" Nominal Face Width

17	412-17	2.721	2.649	B	1.00	1.38	1.88	3.75	3.0	Steel
19	412-19	3.038	2.973	B	1.00	1.63	2.25	3.75	4.0	Steel
21	412-21	3.355	3.297	B	1.00	1.88	2.56	3.75	5.5	Steel
23	412-23	3.672	3.621	B	1.00	2.13	2.88	3.75	7.0	Steel
25	412-25	3.989	3.945	B	1.00	2.38	3.19	3.75	9.0	Steel
38	412-38	6.055	6.038	B	1.00	2.50	4.00	3.75	22.0	Steel
38	412-38 TLB	6.055	6.038	D	2517 TLB			1.75	10.0	Steel
57	412-57	9.076	9.077	C	1.25	2.50	4.50	4.00	53.0	Steel
57	412-57 TLB	9.076	9.077	D	2525 TLB			2.50	37.0	Steel
76	412-76	12.099	12.108	C	1.25	2.50	4.50	4.00	36.5	Cast Iron
76	412-76 TLB	12.099	12.108	D	2525 TLB		4.50	2.50	27.5	Cast Iron
95	412-95	15.122	15.135	C	1.38	3.00	6.00	4.00	74.0	Cast Iron
95	412-95 TLB	15.122	15.135	D	2525 TLB		6.00	2.50	47.5	Cast Iron
114	412-114	18.146	18.162	C	1.38	3.00	6.00	4.00	68.5	Cast Iron
114	412-114 TLB	18.146	18.162	D	3030 TLB		6.00	3.00	53.5	Cast Iron

## 3/4" PITCH

### 3" Nominal Face Width

Number of Teeth	Part Number	Pitch Diameter	Outside Diameter	Hub Type	Minimum Plain Bore	Maximum Bore	Hub Diameter	Length Thru Bore	Approx Weight(lb)	Material
17	612-17	4.082	3.974	B	1.25	2.06	2.88	3.75	8.0	Steel
19	612-19	4.557	4.46	B	1.25	2.38	3.38	3.75	11.0	Steel
21	612-21	5.032	4.946	B	1.25	2.75	3.88	3.75	14.0	Steel
23	612-23	5.508	5.432	B	1.38	3.25	4.38	3.75	18.0	Steel
25	612-25	5.984	5.918	B	1.38	3.63	4.81	3.75	22.0	Steel
38	612-38	9.082	9.058	C	1.38	3.00	4.50	4.00	50.0	Steel
38	612-38 TLB	9.082	9.058	D	2525 TLB		6.00	2.50	36.0	Steel
57	612-57	13.615	13.616	C	1.38	3.50	6.00	4.00	58.0	Cast Iron
57	612-57 TLB	13.615	13.616	D	3030 TLB		6.00	3.00	41.0	Cast Iron
76	612-76	18.149	18.162	C	1.38	3.50	6.00	4.00	65.5	Cast Iron
76	612-76 TLB	18.149	18.162	D	3030 TLB		6.00	3.00	52.0	Cast Iron
95	612-95	22.684	22.703	C	1.50	4.50	7.75	4.00	100.0	Cast Iron
95	612-95 TLB	22.684	22.703	D	3535 TLB		7.75	3.50	96.0	Cast Iron
114	612-114	27.219	27.243	C	1.50	4.50	7.75	4.00	131.5	Cast Iron
114	612-114 TLB	27.219	27.243	D	3535 TLB		7.75	3.50	121.5	Cast Iron

Unless indicated, all dimensions in inches

# SPROCKET DIAMETERS

## CALCULATING OUTSIDE DIAMETERS

In the tables below, locate the diameter factor that corresponds to the number of teeth in your sprocket and your chain type. Multiply this factor by the sprocket pitch (in inches) to obtain the outside diameter in inches.

### RPV SPROCKETS-OUTSIDE DIAMETER FACTORS

Number of Teeth	Diameter Factor		Number of Teeth	Diameter Factor		Number of Teeth	Diameter Factor		Number of Teeth	Diameter Factor	
	Type139	Type 115		Type139	Type 115		Type139	Type 115		Type139	Type 115
18	5.376	5.652	39	12.147	12.403	60	18.856	19.104	81	25.552	25.796
19	5.701	5.977	40	12.467	12.723	61	19.173	19.424	82	25.869	26.115
20	6.027	6.301	41	12.787	13.041	62	19.493	19.743	83	26.189	26.433
21	6.349	6.625	42	13.107	13.361	63	19.811	20.061	84	26.507	26.751
22	6.675	6.948	43	13.427	13.681	64	20.131	20.380	85	26.827	27.069
23	6.997	7.271	44	13.747	14.000	65	20.451	20.699	86	27.144	27.388
24	7.320	7.593	45	14.067	14.320	66	20.768	21.017	87	27.464	27.707
25	7.643	7.916	46	14.384	14.639	67	21.088	21.336	88	27.781	28.025
26	7.976	8.237	47	14.704	14.959	68	21.405	21.655	89	28.101	28.344
27	8.296	8.559	48	15.024	15.277	69	21.725	21.973	90	28.419	28.661
28	8.619	8.880	49	15.344	15.596	70	22.045	22.292	91	28.739	28.980
29	8.941	9.201	50	15.664	15.916	71	22.363	22.611	92	29.056	29.299
30	9.261	9.521	51	15.981	16.235	72	22.683	22.929	93	29.373	29.617
31	9.584	9.843	52	16.301	16.553	73	23.000	23.248	94	29.693	29.936
32	9.904	10.163	53	16.621	16.872	74	23.320	23.567	95	30.011	30.255
33	10.224	10.483	54	16.941	17.192	75	23.637	23.884	96	30.331	30.572
34	10.547	10.803	55	17.259	17.511	76	23.957	24.203	97	30.648	30.891
35	10.867	11.124	56	17.579	17.829	77	24.275	24.521	98	30.968	31.209
36	11.187	11.444	57	17.899	18.148	78	24.595	24.840	99	31.285	31.528
37	11.507	11.763	58	18.216	18.467	79	24.915	25.159	100	31.605	31.847
38	11.827	12.083	59	18.536	18.785	80	25.232	25.477			

### RP AND SC SPROCKETS-OUTSIDE DIAMETER FACTORS

Number of Teeth	Diameter Factor	Number of Teeth	Diameter Factor	Number of Teeth	Diameter Factor	Number of Teeth	Diameter Factor
18	5.623	39	12.397	60	19.112	81	25.809
19	5.947	40	12.717	61	19.431	82	26.128
20	6.271	41	13.037	62	19.750	83	26.447
21	6.595	42	13.357	63	20.070	84	26.766
22	6.919	43	13.677	64	20.388	85	27.084
23	7.243	44	13.997	65	20.708	86	27.403
24	7.568	45	14.317	66	21.027	87	27.722
25	7.890	46	14.637	67	21.346	88	28.040
26	8.213	47	14.957	68	21.665	89	28.359
27	8.536	48	15.227	69	21.984	90	28.678
28	8.859	49	15.597	70	22.303	91	28.997
29	9.181	50	15.917	71	22.622	92	29.315
30	9.504	51	16.236	72	22.941	93	29.634
31	9.828	52	16.556	73	23.259	94	29.953
32	10.150	53	16.876	74	23.578	95	30.271
33	10.471	54	17.196	75	23.897	96	30.590
34	10.793	55	17.515	76	24.216	97	30.909
35	11.115	56	17.834	77	24.535	98	31.228
36	11.437	57	18.154	78	24.853	99	31.546
37	11.757	58	18.473	79	25.172	100	31.865
38	12.149	59	18.793	80	25.491		

# ORDERING INFORMATION

## CHAIN ORDERING INFORMATION

If you know the chain's part number...

Simply supply the part number along with the chain length in pitches, feet or meters.

If you have a chain description, but do not know the part number...

Please specify the following details.

- Product type: For example, RPV, RP, SC or competitors product type
- Pitch: Best determined by measuring across 3 pin heads and dividing the measurement by 2.
- Chain width across the links and across the heads
- Guide type
- Chain length in pitches, feet or meters

If you have an engineering drawing...

Simply fax, email, or mail the drawing to Ramsey.

If you are uncertain about what you need...

Contact Ramsey. Our experienced sales engineers will be pleased to assist you in identifying a chain for your application.

## SPROCKET ORDERING INFORMATION

If you know your sprocket part number...

Simply supply the part number along with the following details:

- Hub type A, B, C or D
- Hub projection
- Bore diameter
- Keyway size
- Hub diameter

If you know your chain part number...

A compatible sprocket can be identified by the chain part number followed by the number of sprocket teeth. For example a 21 tooth sprocket for a RamPower 1/2" pitch by 1" wide chain can be specified as RP404-21. Also please supply the following machining details:

- Hub type A, B, C or D
- Hub projection
- Bore diameter
- Keyway size
- Hub diameter

If you have an engineering drawing...

Simply fax, email, or mail the drawing to Ramsey. After a review of the drawing we will respond to your inquiry and supply a quotation if desired.

If you are uncertain about what you need...

Contact Ramsey. Our experienced sales engineers will be pleased to assist you in identifying sprockets for your application.

# ENGINEERING INFORMATION

## DESIGN SUGGESTIONS

**SPROCKETS:** For long life, sprockets should have a minimum of 21 teeth. For smoother, quieter drives use a larger number of teeth.

**DRIVE RATIOS:** Ratios of 12:1 or greater are possible, but above 8:1 it is usually desirable to make the reduction in two steps.

**SHAFT CENTER ADJUSTMENT:** Center adjustment to allow for wear is always desirable. It is particularly important in vertical center drives. Typically the amount of adjustment should equal at least 1% of the center distance.

**SHAFT CENTER DISTANCE:** The center distance should be great enough that the chain wraps the small sprocket at least 120 degrees. Center distances should generally not exceed 60 pitches.

**CHAIN LENGTH:** Whenever possible, chain length should be an even number of pitches so an offset section can be avoided.

**TENSIONING DEVICES:** An idler sprocket or shoe can often be used to maintain tension on fixed center drives.

**CHAIN WIDTH:** The use of a wider than recommended chain will result in a more rugged drive and improved drive life.

**DRIVE ENCLOSURES:** Fully enclosed drives with proper lubrication are desirable for maximum service life and personnel safety.

**NON-HORIZONTAL AND VERTICAL SHAFTS:** Drives using non-horizontal shafts often work best with side guide chain and an automatic tensioner. Consult Ramsey for specific recommendations.

## DRIVE POSITIONS

The preferred position for a drive is where a line between shaft centers is horizontal or inclined not more than 45 degrees. Under ordinary conditions the slack strand may be either on the upper or lower side of the drive.

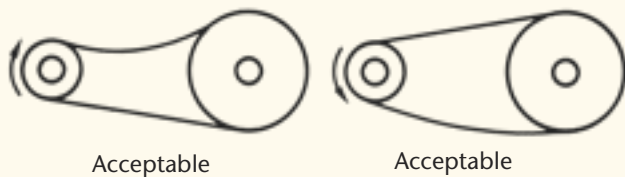

Vertical drives should be avoided if possible. They must be run fairly taut which means frequent adjustment of centers as the chain elongates due to normal wear. Less care and adjustment will be required if the drive can be positioned slightly off the vertical.

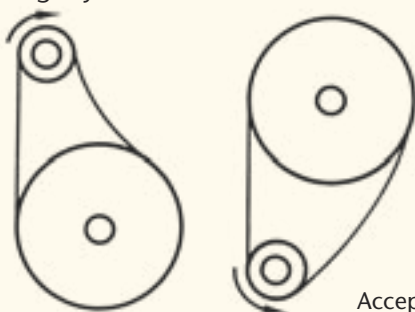

Where the center distance is comparatively short, slack on the lower strand is preferable. With the slack on the upper strand there is a tendency for the chain to be forced out of proper engagement with the sprockets.

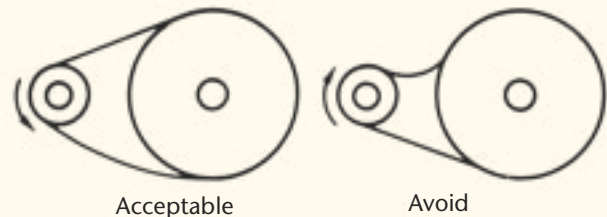

Drives with long center distances and small sprockets should have the slack strand on the bottom. With the slack on top there is danger of the upper strand hitting the lower as the chain elongates.

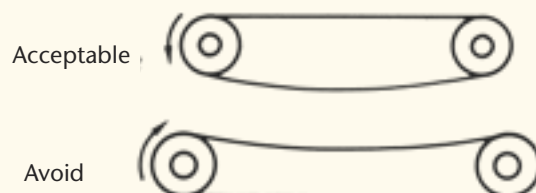

## DRIVE SELECTION-STEP BY STEP

Drive selection consists of choosing the appropriate chain and sprockets for the space, loads, and speeds involved. Often more than one pitch and width will work in a given situation. In such cases one may choose two or three possible selections and base the final choice on factors such as cost, stock availability, ruggedness or space availability. Contact Ramsey for a computer program that simplifies the drive selection process.

### Information Needed

- Type of power source and application
- Power to be transmitted (W)
- RPM of shafts (N1=faster shaft speed, N2=slower shaft speed)
- Shaft center distance (CD)
- Shaft diameters and keyway sizes

## FOLLOW THESE STEPS

1. Choose a service factor (SF) from the table on page 31
2. Compute the design power ( $W_d$ ) by multiplying the power to be transmitted (W) by the service factor.
3. Use the speed of the faster moving shaft (N1) to make a tentative pitch selection(p) from the chart below.

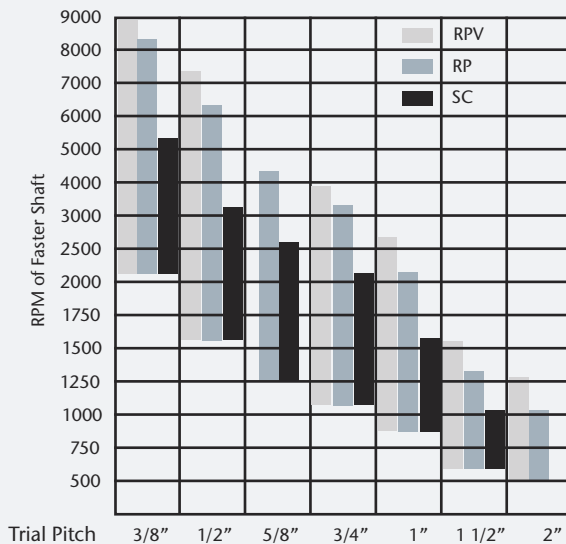

4. Select the number of teeth in the small sprocket ( $Z_1$ ), making sure the sprocket can accommodate the shaft diameter. See maximum sprocket bores in sprocket tables.
5. Use the following equations to calculate the required chain width ( $C_w$ ). If the required chain width is not readily available it may be necessary to go to a wider chain or a larger sprocket.

$$\text{For RPV and RP} \quad C_w = \frac{22.3(W_d)}{p \cdot V \cdot R (1 - V^2(1.34 \times 10^{-8}))}$$

$$\text{For SC} \quad C_w = \frac{18,000(W_d)}{p \cdot V (425 - V/(Z_1 - 8))}$$

$C_w$  = required width (inches),  $W_d$  = design power (hp)  
 $R$  = factor from table,  $p$  = pitch (inches),  $V$  = chain speed (ft/min)

Table of R Values\*

	Pitch						
	3/8"	1/2"	5/8"	3/4"	1"	1 1/2"	2"
RPV (SG)	1.5	1.8	na	1.6	1.5	1.1	1.0
RPV (CG)	1.5	1.8	na	1.3	1.2	1.1	1.0
RP	0.922	1.0	1.0	1.0	1.0	1.0	1.0

6. Select the large sprocket ( $Z_2$ ) by multiplying the number of teeth in the small sprocket by the desired shaft speed ratio.  
 $Z_2 = Z_1 \times N_1/N_2$

7. Compute the chain length using the table provided on page 26. If the computed length is fractional, round off to the nearest whole number of pitches. An even number of pitches is always preferable to an odd number of pitches which requires an offset section. If an offset section is required it will be necessary to increase the width of the chain by 25% to account for the offsets reduced tensile strength. Note: offset sections are not available for RPV chain.

8. Compute the new center distance ( $C_d$ ) for the rounded off chain length. The following formula provides an approximate center distance. When fixed center drives are used or extremely accurate center distance is required consult Ramsey.

$$C_d = \frac{C_L - \frac{(Z_1 + Z_2)}{2}}{4} + \text{SQRT} \left( \frac{C_L - \frac{(Z_1 + Z_2)}{2}}{2} - 8 \frac{(Z_2 - Z_1)^2}{4\pi^2} \right)$$

Where:

- $C_d$  = corrected center distance in pitches
- $C_L$  = chain length in pitches
- $Z_1$  = number of teeth in smaller, faster moving sprocket
- $Z_2$  = number of teeth in larger, slower moving sprocket

9. Select a method for lubricating the drive.  
 Forced feed lubrication will provide optimum results and is recommended whenever chain speeds exceed 2500 ft/min. Drip or bath type lubrication may be acceptable at lower speeds. Additional information on lubrication is given in the section describing lubrication. Also, if the drive will not operate inside a housing, a chain enclosure is recommended.

\* Tabulated values for RPV based on Type 139 link design for 3/8" through 1" pitch and Type 115 link design for 1 1/2" and 2" pitch



# DRIVE SELECTION EXAMPLE

## DRIVE SELECTION

Fan (centrifugal)

Power source: electric motor

Power: 35 hp

Shaft RPM: 1750 RPM (N1), 800 RPM (N2)

Center distance: 28 inches, adjustable centers

Shaft diameter = 1.500 inches

- Determine the service factor (SF), using chart on page 31  
Service factor = 1.3
- Calculate the design power ( $W_d$ )  
 $W_d = W \times SF = 35 \text{ hp} \times 1.3 = 45.5 \text{ hp}$
- Choose an initial pitch (p)  
Entering the pitch selection chart (page 25) at 1750 rpm, select 1/2" pitch RP series chain. Note, SC or RPV chain could have been selected.
- Select the number of teeth in the small sprocket (Z1).  
A minimum of 21 teeth is recommended. From the sprocket table on page 20, the maximum bore for a 21 tooth sprocket is 47.6mm. This is greater than the shaft diameter so the sprocket choice is acceptable.

- Calculate minimum chain width ( $C_w$ )

$$W_d = 45.5 \text{ hp}$$

R = 1.0, from table on page 25

$$V = pZN = (0.5 \times 21 \times 1750)/12 = 1,531 \text{ fpm}$$

$$C_w = \frac{(22.3 \times 45.5)}{(0.5 \times 1,531 \times 1.0) \times (1 - [(1,531)^2 \times (1.34 \times 10^{-8})])}$$

$$C_w = 1.37 \text{ inches}$$

The nearest larger standard chain width, from page 10, is 1.5 inches wide, RP406

- Calculate the number of teeth in the larger sprocket (Z2)  
 $Z2 = Z1 \times (N1/N2) = 21 \times 2.19 = 46 \text{ teeth}$
- Calculate the chain length ( $C_L$ )  
 $C = 56, A = 67, S = 25$   
  
From table below  $T = 15.83$ , and  $C_L = 145.8$  pitches  
Round to even number of pitches,  $C_L = 146$  pitches
- Calculate the new center distance ( $C_d$ )  
From page 25,  $C_d = 56.109$  pitches or 28.054 inches.

## CHAIN LENGTH CALCULATION

### Information Needed:

- CD = center distance (inches)  
Z2 = number of teeth in large sprocket  
Z1 = number of teeth in small sprocket  
p = chain pitch (inches)

### Procedure

- Calculate C, where  $C = CD/p$
- Calculate A, where  $A = Z1 + Z2$
- Calculate S, where  $S = Z2 - Z1$
- Refer to the below and find the T value corresponding to the calculated S value.
- Chain length in pitches,  $C_L = 2C + (A/2) + (T/C)$

Note: If chain length is fractional round off to the nearest whole number of pitches. An even number of pitches is always preferable to an odd number which requires an offset section.

An offset section (also called a hunting link section) must be used when a chain contains an odd number of links. If an offset section is required, it will be necessary to increase the width of the chain by 25% to account for the reduced tensile strength of the offset.

S	T	S	T	S	T
1	0.03	35	31.03	69	120.60
2	0.10	36	32.83	70	124.12
3	0.23	37	34.68	71	127.69
4	0.41	38	36.58	72	131.31
5	0.63	39	38.53	73	134.99
6	0.91	40	40.53	74	138.71
7	1.24	41	42.58	75	142.48
8	1.62	42	44.68	76	146.31
9	2.05	43	46.84	77	150.18
10	2.53	44	49.04	78	154.11
11	3.06	45	51.29	79	158.09
12	3.65	46	53.60	80	162.11
13	4.28	47	55.95	81	166.19
14	4.96	48	58.36	82	170.32
15	5.70	49	60.82	83	174.50
16	6.48	50	63.33	84	178.73
17	7.32	51	65.88	85	183.01
18	8.21	52	68.49	86	187.34
19	9.14	53	71.15	87	191.73
20	10.13	54	73.86	88	196.16
21	11.17	55	76.62	89	200.64
22	12.26	56	79.44	90	205.18
23	13.40	57	82.30	91	209.76
24	14.59	58	85.21	92	214.40
25	15.83	59	88.17	93	219.08
26	17.12	60	91.19	94	223.82
27	18.47	61	94.25	95	228.61
28	19.86	62	97.37	96	233.44
29	21.30	63	100.54	97	238.33
30	22.80	64	103.75	98	243.27
31	24.34	65	107.02	99	248.26
32	25.94	66	110.34	100	253.30
33	27.58	67	113.71		
34	29.28	68	117.13		

# LUBRICATION

## CHOOSE THE PROPER LUBRICANT

Proper drive lubrication is essential for a long service life. In sufficient quantities a lubricant penetrates chain joints to protect against corrosion, dissipate heat, cushion impact, and flush away debris. The chain width equations on page 25 presume that adequate lubrication is used.

For most applications a good grade of non-detergent petroleum based oil is recommended. Multiviscosity oils are not recommended. Generally greases and high viscosity oils are too thick to penetrate chain joints and should be avoided.

A chain which does not receive sufficient lubrication will wear prematurely. An early indication is the appearance of a reddish brown, iron oxide deposit on the chain. When this is found the method and/or quantity of lubricant should be improved.

Chain drives should also be covered or enclosed in a manner that will protect the oil from contamination by dirt or moisture. For best results oil should be filtered and cooled when necessary.

Ambient Temperature (°F)	Recommended Lubricant
< 40	SAE 5*
40-90	SAE 10*
> 90	SAE 20

\* Type A or B Automatic Transmission Fluid may be substituted

## LUBRICATION METHODS

### Type I - Manual And Drip Lubrication

Oil is applied periodically to the inside of the chain with a brush, drip tube, or oil can. With a drip feed system, one oil drop opening should be provided for each 0.75 inches of chain width. The volume and frequency of lubrication should be enough to prevent chain overheating or discoloration.

This method may be suitable for applications involving low speeds and loads, or short duty cycles. It is not generally recommended for chain speeds exceeding 1,000 ft/min.

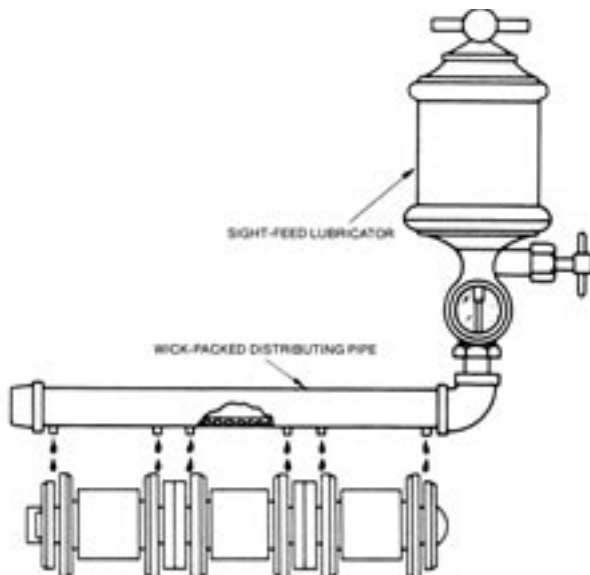

Warning: Do not attempt to manually lubricate or service any chain drive while it is operating. Serious injury could result.

# LUBRICATION

## Type II - Bath and Disc Lubrication

**Bath**-The lower strand of chain runs through an oil bath. The oil level should be such that the pitch line of the chain is just submerged. Also, to prevent excessive heat generation, only a short section of chain should run through the bath.

**Disc**-A rotating disc picks up oil from a reservoir and directs it to the chain by means of a baffle or trough. The chain is not submerged in oil. This method requires that the disc rim speed be between 800 ft/min and 8,000 ft/min.

These methods may be suitable for chain speeds up to approximately 2,500 ft/min.

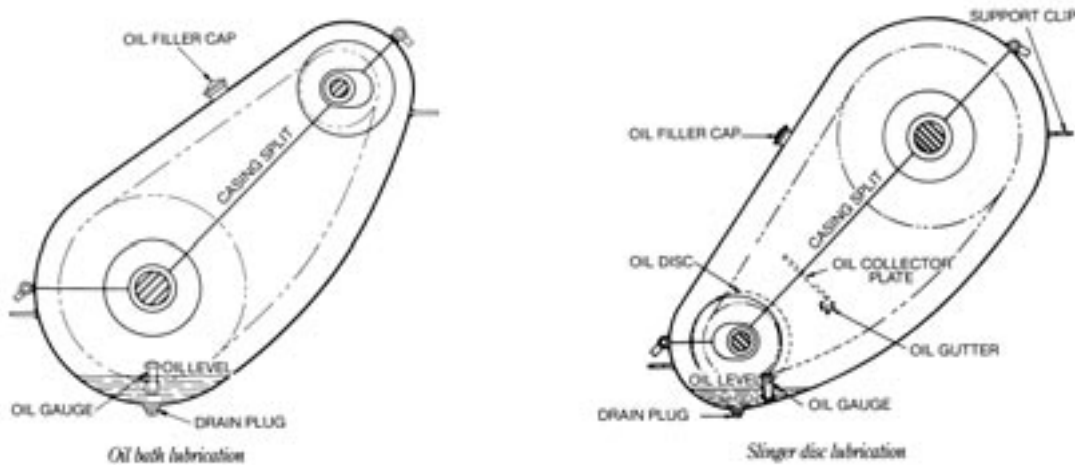

## Type III - Force Feed Lubrication

Lubricant is supplied in a continuous stream by a circulating pump and distribution pipe. The oil should be directed to the inside of the slack strand with one oil stream for each 1 inch of chain width. This is the preferred method of lubrication, particularly for drives with heavy loads or speeds greater than 2,500 ft/min. Recommended oil flow rates will vary depending on the application. The equation below lists minimum recommended flow rates based on the power transmitted. In general, oil flow rates should be 1 gallon per minute, for every 1 inch of chain width.

### Minimum Flow Rates

$$F = \frac{Pw + 0.5}{200}$$

Where:

F = Flow rate in gallons per minute

Pw = Power transmitted in horsepower

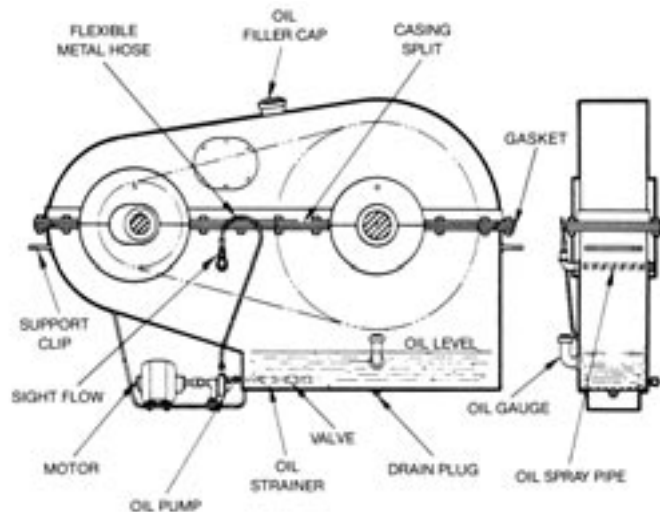

# INSTALLATION GUIDELINES

## DRIVE INSTALLATION

### Shaft Parallelism

Shaft parallelism should be checked before installing sprockets. Typically shafts should be parallel to within 0.005 inches per foot. Ramsey should be consulted for applications where shafts are not horizontal.

### Sprocket Alignment

Sprockets should be aligned on the shafts so there is little or no lateral offset between sprocket faces. Excessive wear will result if the sprockets are not properly aligned.

### Chain Connection

A variety of connector styles are used in Ramsey chain, depending on the chain type and customer preference. See page 30 for illustrations of the most common styles.

During connection, It is very important that the ends of the chain be properly laced together and that the pins be inserted with their convex surfaces facing one another.

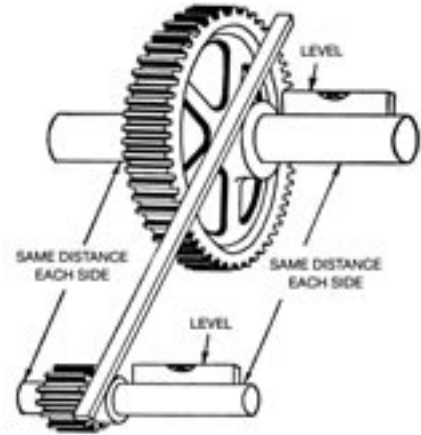

Chain clamped to the sprocket to simplify connection.



Symmetric chain lacing during connection

### Tensioning

Chains must be properly tensioned at installation and checked periodically. Chain life will be shortened both by running too tight and running too loose. A chain which is too tight has an additional load imposed on it which will accelerate wear and increase noise. A chain which is loose enough to whip or surge can be subjected to shock loads and excessive wear.

On drives where the line between shaft centers is horizontal or inclined as much as 60 degrees from horizontal, the chain should be tensioned to allow a sag in one strand equal to approximately two percent of the shaft center distance. The chain should be taut in vertical or fixed center drives, and on drives subject to shock loads, reversing, or dynamic braking.

# CHAIN CONNECTION

## CONNECTION

Once the links in each end are properly laced together, chain connection is completed by first inserting the longer pin and then the shorter pin. Position the pins so that the convex surfaces contact one another. Complete the connection by putting a washer or side link on the long pin where appropriate and then fasten with a spirol pin or cotter. Optional annealed connecting pins are available that are secured by peening over the pin end. The illustrations show the most common connection methods; other methods are available upon request.

### FOR RPV AND RP CHAINS 3/8" - 1/2" PITCH



Bring the ends of the chain together so the holes are aligned



Insert longer pin through the chain.



Insert short pin so convex pin surfaces are in contact



Install spirol roll pin

### FOR RPV AND RP CHAINS 5/8" - 2" PITCH



Bring the ends of the chain together so the holes are aligned



Insert longer pin through the chain.



Insert short pin so convex pin surfaces are in contact



Put washer on long pin and install cotter or spirol roll pin

### FOR SC CHAINS 3/8" - 1" PITCH



Bring the ends of the chain together so the holes are aligned



Insert longer pin through the chain.



Insert short pin so convex pin surfaces are in contact



Put washer on long pin and install cotter.

Other chain connections are available



# SERVICE FACTORS

Service factors are used during drive selection to compensate for less than optimum drive conditions. The chain width formulas on page 25 are based on the following drive conditions:

- Power source = electric motor, hydraulic motor, turbine, or engine with fluid coupling
- Proper lubrication

For conditions that differ from those listed above, the power to be transmitted must be multiplied by a service factor to obtain the design power. The design power is then used to calculate the required chain width.

Select an appropriate service factor from the service factor table, then add one or more of the additional factors listed here:

Fixed center distance = 0.2

Engine with mechanical coupling = 0.2

Inadequate lubrication = 0.2 to 0.5

## Service Factor Table

AGITATORS (paddle or propeller)		DREDGES		Draw works	1.8
Pure liquid	1.1	Conveyors, cable reels	1.4	Chillers, Paraffin filter presses, Kilns	1.5
Liquids (variable density)	1.2	Jigs, screens	1.6	PAPER INDUSTRY MACHINERY	
BAKERY MACHINERY		Cutter head drives	Consult Ramsey	Agitators, bleachers	1.1
Dough Mixer	1.2	Dredge pumps	1.6	Barker( mechanical)	1.6
BLOWERS	See Fans	FANS & BLOWERS		Beater, Yankee Dryer	1.3
BREWING & DISTILLING EQUIPMENT		Centrifugal, propeller, vane	1.3	Calendars, Dryer, Paper Machines	1.2
Bottling Machinery	1.0	Positive blowers (lobe)	1.5	Chippers,winder drums	1.5
Brew Kettles, cookers, mash tubs	1.0	GRAIN MILL MACHINERY		PRINTING MACHINERY	
Scale Hopper (Frequent starts)	1.2	Sifters, purifiers, separators	1.1	Embossing, flat bed presses, folders	1.2
BRICK & CLAY EQUIPMENT		Grinders, hammer mills	1.2	Paper cutter, rotary press, linotype	1.1
Auger machines, cutting table	1.3	Roller mills	1.3	Magazine, Newspaper Presses	1.5
Brick machines, dry press, granulator	1.4	GENERATORS & EXCITERS	1.2	PUMPS	
Mixer, pug mill, rolls	1.4	ICE MACHINES	1.5	Centrifugal, gear, lobe, vane	1.2
CEMENT PLANTS		LAUNDRY MACHINERY		Dredge	1.6
Kilns	1.4	Dampeners, Washers	1.1	Pipe line	1.4
CENTRIFUGES	1.4	Tumblers	1.2	Reciprocating (3 or more cyl.)	1.3
COMPRESSORS		MACHINE TOOLS		Reciprocating (1 or 2 cyl.)	1.6
Centrifugal, rotary (lobe)	1.1	Grinders, lathes, drill press	1.0	RUBBER & PLASTICS EQUIPMENT	
Reciprocating (1 or 2 cyl.)	1.6	Boring mills, milling machines	1.1	Calendars, rolls, tubers	
Reciprocating (3 or more cyl.)	1.3	MARINE DRIVES	Consult Ramsey	Tire-building, Banbury Mills	1.5
CONSTRUCTION EQUIPMENT		MILLS		Mixers, sheeters	1.6
OR OFF-HIGHWAY VEHICLES		Rotary type:		Extruders	1.5
Drive line , power take-off	Consult Ramsey	Ball, Pebble, Rod, Tube, Roller	1.5	SCREENS	
Accessory drives		Dryers, Kilns, tumbling barrels	1.6	Conical, revolving	1.2
CONVEYORS		Metal type:		Rotary, gravel, stone, vibrating	1.5
Apron, bucket, pan, elevator	1.4	Draw bench carriage, main drive	1.5	STOKERS	1.1
Belt (ore, coal, sand, salt)	1.2	FORMING MACHINES	Consult Ramsey	DYNAMOMETERS	Consult Ramsey
Belt (light packages, oven)	1.0	MIXERS		TEXTILE INDUSTRY	
Screw, flight (heavy duty)	1.6	Concrete	1.6	Spinning frames, twistlers, Wrappers	1.0
CRANES & HOISTS		Liquid, Semi-liquid	1.1	Batchers, calendars, looms	1.1
Main hoist (medium duty)	1.2	OIL INDUSTRY MACHINERY			
Main hoist (heavy duty), skip hoist	1.4	Compounding Units	1.1		
CRUSHING MACHINERY		Pipe line pumps	1.4		
Ball mills, crushing rolls, jaw crushers	1.6	Slush pumps	1.5		

## INSPECTION

Periodic drive inspection and adjustment will often result in increased service life and lower costs. An inspection should include sprocket alignment, tension, lubrication, and the general condition of chain and sprockets.

## TENSIONING AND ELONGATION

As a chain wears, its pitch will elongate and the chain will wrap an increasingly larger pitch circle. Re-tensioning of the chain will normally eliminate problems associated with excess chain slack. Also, with Ramsey chains this elongation occurs uniformly throughout the length of the chain so efficient, smooth operation is maintained.

However, when elongation becomes excessive the chain can skip teeth and damage the sprocket. It is best to replace the chain before this happens. The size of the large sprocket will limit the allowable elongation of the chain. In general, a chain will not properly wrap sprockets when it has elongated by  $200/N\%$  where  $N$  = the number of teeth in the larger sprocket. Other application related considerations may further limit the amount of acceptable elongation.

## Alignment

Sprocket alignment must be maintained for optimum drive performance and chain life. Examine the sides of the chain guide links for excessive wear or gouging; these are often symptoms of misaligned sprockets.

Periodically check that sprockets are securely fastened. If sprocket position has changed since installation go through the alignment procedure used during installation.

## ENGINEERING FORMULAS

$p$  = pitch in inches  
 $Z$  = number of teeth in sprocket  
 $V$  = chain speed in feet per minute  
 $W$  = power in horsepower  
 $N$  = revolutions per minute  
 $P_d$  = pitch diameter in inches  
 $L$  = working load in pounds  
 $T$  = torque in inch pounds

$$W = \frac{TN}{63,025} \quad L = \frac{396,000W}{pZN}$$

$$T = \frac{LP_d}{2}$$

$$W = \frac{VL}{33,000} \quad L = \frac{33,000W}{V}$$

$$T = \frac{63,025W}{N}$$

$$P_d = \frac{p}{\sin(180/Z)} \quad V = \frac{pZN}{12}$$

Ramsey Products Corporation  
135 Performance Drive  
Belmont, NC 28012  
Tel: (704) 394-0322  
Fax: (704) 394-9134  
www.ramseychain.com  
sales@ramseychain.com



Ramsey Europe  
Germany  
Tel: +49 151 24042790  
Ireland  
Tel: +353 (0) 892727769  
euro.sales@ramseychain.com